

DOVER

QUICK LOCATOR GUIDE

Belts	560
Brushes And Brush Holders	561
Car Signal Components	540-560
Emergency Light Components	556-577
Emergency Stop Switches	540
Gongs and Buzzers	560
Hall Lantern	544
Hall Station Assemblies	545
Key Switches, Keys	542-543, 549-555
Lamps, Lamp Holders	544-545
Position Indicator Components	544, 548, 559
Pushbutton Assemblies	541, 547
Capacitors	564
Carbon Contacts And Holders	561
Coils	565
Contacts And Contact Kits	562-564
Contactors, Starters	564, 590-591
Door Parts And Equipment	566-574
Clutch Components	572
Gibs, Guide Shoe	569-570
Hatch Equipment	574
Interlock Components	567
Motors	571
Operator, DMC	573
Pick-up Roller Assembly	566
Restrictor Assemblies	573
Encoders and Tachometers	575
Fan / Blower	586
Machine Parts	575-577
Printed Circuit Boards	578-585
Rectifiers	582, 586
Relays	587-590
Resistors	587
Safety Edge Equipment	592-593
Selector Parts	594-597
Transformers	598
Valve Components	598-600
Wheels and Rollers	600-602

DOVER

Car Signal Components

DOVER

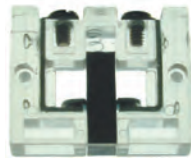

DB-5



DB-6



DB-6A

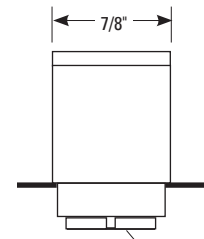

DB-6C

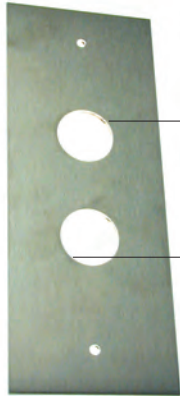

DB-14



DB-7

2-3/8"
c/c



DB-7A

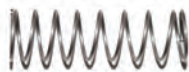

DB-80



TPB-004



TPB-213



DB-3A



DB-3D



DB-3B

S.E.E.S. #	O.E.M. #	Description
DB-1M	9827018	Pushbutton, Microswitch replacement for DB-1, 2, 3
DB-1M-SPECIAL		Pushbutton, Microswitch with Special Engraving & Lamp Holder
DB-3M	9930840	Pushbutton Assembly, Stop-FR
DB-5	9724522, 32455	Contact assembly, normally closed
DB-6-	9852130, 9850119	Pushbutton, 7/8" diameter x 1-5/32" long, black button with white character, specify marking, i.e. DB-6-2
DB-6A	9724989, 32489	Push plate, for button
DB-6C	32491	Retaining ring, for push plate
DB-7	9724588	Car Halo for pushbutton, 1-3/8" O.D. x 7/8" I.D.
DB-7A	9828230	Pushbutton Halo, back mounting, white halo for DB-6 button
DB-7B	9828199	Pushbutton Halo, back mounting, black halo for DB-6 button
DB-80	780AD1	Pushbutton Spring, V-7 Dover impulse switch
DB-13	9826919	Plate, stainless steel, 3-1/2" x 9" with single 1-1/4" dia. hole, mounting studs 7-1/8" c/c
DB-13A		Terminal Hole Plate, DB-8F-ARROW-ADA 3-3/8" x 9-3/4", 7-1/2" C-C Holes
DB-14	9826920, 9832609	Plate, stainless steel, 3-1/2" x 9" with two 1-1/4" dia. holes 2-3/8" c/c, mounting studs 7-1/8" c/c
DB-14A	9826920,	Terminal Hole Plate, DB-8F-ARROW-ADA 3-3/8" x 9-3/4", 7-1/2" C-C Holes
DB-14A-CB		Intermediate Hole Plate, DB-8F-ARROW-ADA (1) Code Blue Keyswitch, 3-1/2" x 9", 7-1/2" C-C Holes
TPB-004	9846352	Contact, Pushbutton
TPB-RING		Vandal Ring, for TPB Series
TPB-213	9872314	Button, Vandal Resistant Calif V10
TPB-200	9739490	Button, Blank Stainless for Vandal Resistant
TPB-002	9835641	Pushbutton, 24V Vandal Resistant, LED illuminated

Emergency Stop Switch

S.E.E.S. #	O.E.M. #	Description
DB-3A	9810857, 108150	Stop switch assembly, horizontal, red button 1-1/4" dia., 1 Make 1 Break, marked "PUSH STOP/PULL RUN"
DB-3B	9810985, 109888	Stop switch assembly, horizontal, red button 1-1/4" dia., marked "PUSH INSPECTION/PULL AUTO or PULL RUN", 1 Make 1 Break
DB-3D	9810845	Stop switch assembly, vertical, red button 1-1/4" dia., marked "PUSH STOP/PULL RUN", 1 Make 1 Break

Car Signal Components

S.E.E.S. #	O.E.M. #	Description
DB-3E		Key Switch , halo marked "DOOR HOLD", 2 position, key removable in OFF only, H2395 key, black, round bezel
DB-3F		Key Switch , halo marked "RUN/STOP", 2 position, key removable in ON only, H2395 key, red, round bezel
DB-3F-BLK		Key Switch , Run-Stop, Rnd Black 2 Pos, 2Rmv, H2395 Key
DB-3F-SH		Key Switch , Run-Stop 1-1/4" SQ 2 Pos, Rmv1, Horiz, H2395 Key, square bezel
DB-3F-SV		Key Switch , Run-Stop 1-1/4" SQ 2 Pos, Rmv1, Vert, H2395 Key, square bezel



DB-3E



DB-3F

Toggle Style Stop Switch

S.E.E.S. #	O.E.M. #	Description
DS-52	171AR46	Switch
DB-53	32554	Halo , black, marked "RUN/STOP", for toggle switch, 1-1/4" diameter, plate 1.56 x 2.44, 2" c/c mounting
DB-53A	42823	Halo , blank, black, for toggle style stop switch
DB-53B		Halo , black, marked "DOOR HOLD", for toggle switch
DB-53C	138595	Spacer , Round for Pushbutton
DB-54	32553	Bracket for toggle stop switch, 3/4" x 2-3/8" plate
DB-55	9867053, 76705	Switch , 3 PDT, two position, run/stop, 1.1" x 1.33"



DB-53



DB-54



DB-55

Pushbutton Assembly

Item	S.E.E.S. #	O.E.M. #	Description
1	DB-8CADA	9773150	Clear cap , Dover Calif. Code ADA 138354
2	DB-8-ADA	9806738, 106733	Clear cap for pushbutton, 1" diameter x 1/4"
3	DB-8B-"*" -ADA	98930-1, 9890087, 9890129	Button , new ADA style, specify marking, i.e. DB-8B-1-ADA, shown
4	DB-8E	9884063, 107406	Base assembly , 1 normally open, 1 normally closed contact
	DB-8D	9884075, 107407	Base assembly , 2 normally open contacts
5	ML-57	9727190	Lamp , 28 volt, #657
	ML-57-LED-W		Lamp , White 28V LED 4 Chip T3 1/4 Wedge 657 LED white
6	DB-52C	9778147, 10814	Lamp socket with resistor
6	DB-52D	9727164, 9711065	Lamp socket without resistor
	DB-52G	701AB2	Resistor Assembly , 600 Ohms
	DB-52H	900AB16	Wire Assembly , 20GA 110/187 4" Lg
	DB-52F	9719568	Resistor Assembly , 5W 600 Ohms
	DB-8F-"*" -ADA		Pushbutton Assembly , 2 normally open base, new ADA style, specify marking, i.e. DB-8F-1-ADA, shown
	DB-8F-CODE-BLUE-ADA		Pushbutton Assembly , P.B. Indicator, Marked "Code Blue"
	DB-8G-"*" -ADA		Pushbutton Assembly , 1 N.O., 1 N.C., new ADA style, specify marking
	DKS-8-BLANK-H		Bezel , adapts 1-1/4" Round button to keyswitch, horizontal
	DKS-8-BLANK-V		Bezel , adapts 1-1/4" Round button to keyswitch, vertical
	ML-108-LED-W	175AC1	LED , White 85 LED with socket
	DB-8C	9806349	Halo , for new style button



1



2



3



4



5



6



DB-8F-1-ADA



DKS-8-BLANK-H



DB-8C



DB-8F-CODE-BLUE-ADA



DB-8G-G-ADA

Car Signal Components

■ Select one from each section below (1 Rotary Switch, 2 Key Cylinder, and 3 Key Switch Collar) along with a DKS-1B mounting bracket to make a complete switch assembly.



DK-3



DK-4



DK-5



DKS-1A, DKS-2A, DKS-2B



DKS-1B



DKS-76D



DKS-76C



DKS-76E



DKS-8-OFF-ON-FIRE-BY

Rotary Key Switch Assembly

1 – ROTARY SWITCHES

S.E.E.S. #	O.E.M. #	Description
DK-3	H2111	Key H-2111
DK-4	H2007	Key H-2007
DK-5	H2011	Key H-2011
DKS-1	9772870, 77287	Rotary switch, 2 position, ON-OFF
DKS-1A		Key switch, rotary switch 2 position DPDT
DKS-2	9772868, 77286	Rotary switch, 3 position, ON-OFF-ON
DKS-2A		Rotary switch, 3 position, ON-ON-ON Old Style SP3T, Enclosed Switch
DKS-2B	102761	Rotary switch, 3 position, ON-ON-ON New Style Open Face Switch
DKS-1B	9826099, 32609	Bracket, mounting
DKS-1BA		Bracket, for key switch (new style)
DKS-76D		Keyswitch, 2 Pos. Remove 2, Keyed to 2252

2 – KEY CYLINDERS

S.E.E.S. #	O.E.M. #	Description
DKS-3A	9703135	Key H-2395
DKS-4A	9703196	Key H-2389 (Restricted Fire Service Key)
DKS-5A	9703202	Key H-2304
DKS-6	9759542, 35954	Special key cylinder, Two H-2454 keys
DKS-6A	9703214	Key H-2454
DKS-7	9759554, 35955	Special key cylinder, Two H-2567 keys
DKS-7A	9703240	Key H-2567
DKS-8A	9703299	Key H-2573
DKS-12A	9703160	Key H-2237
DKS-76A	9721654	Key H-2165
DKS-76B	H2252	Key Access chair lift H2252 Thyssen
DKS-76C		Key Switch 2 POS. Remove 1, Keyed to 2252
DKS-76E		Key Switch 2 POS. Remove 1, Keyed to 2252, Spring Loaded
DKS-21A	9710280	Key H-5009

3 - KEY SWITCH COLLARS

■ Collar 1-1/4" diameter. Markings are listed in the order that they appear, the first marking is at the 12 o'clock position; unless otherwise noted. Subsequent markings are in the 3 o'clock position, following clockwise to the next position. i.e. DKS-8-OFF-ON-FIRE-BYP, pictured. OFF (12 o'clock position) ON (3 o'clock position) FIRE (6 o'clock position) BYPASS (9 o'clock position).

S.E.E.S. #	O.E.M. # / Marking
DKS-8-ATT-ON-SERVICE	32738/Attendant-On-Service
DKS-8-BLANK	9822987/blank, black collar
DKS-8-BLANK-RED-BYP	117560/Key Core, red blank, for bypass halo
DKS-8-RED BLANK	117559/blank, red collar
DKS-8-DOOR-HOLD	Door-Hold (6)
DKS-8-EMER-ON-POWER	32743/Emergency-On-Power
DKS-8-EMER-ON-SERVICE	32737/Emergency-On-Service
DKS-8-FAN-OFF	32751/Fan-Off (9)
DKS-8-FLOOR-ON-LOCK	Floor-On-Lockout
DKS-8-HOLD-ON-FIRE-OFF	Red Hold-On-Fire-Off, Phase II Car
DKS-8-IND-ON-SERVICE	32736/Independent-On-Service
DKS-8-INDEP-SERVICE	Independent-Service (6)
DKS-8-INSPECTION-ON	32740/Inspection-On
DKS-8-LIGHT-FAN-OFF	32744/Light-Fan-Off (9)
DKS-8-LIGHT-OFF	32750/Light-Off (9)

S.E.E.S. #	O.E.M. # / Marking
DKS-8-MG-OFF	32741/MG-Off (9)
DKS-8-OFF-DN-HOISTWAY	Off-Dn-Hoistway Acc.-Up
DKS-8-OFF-ON	Off-On
DKS-8-OFF-ON-FIRE-BYP	Red Off-On-Fire-Bypass, Phase I Hall (new style) used only with DKS-2B
DKS-8-OFF-ON-FIRE-BY	Red Off-On-Fire-Bypass, Phase I Hall (old style) used only with DKS-2A (shown above)
DKS-8-OFF-ON-FIRESVC	Off-On-Fire Service
DKS-8-OFF-ON-INSPECT	Off-On-Inspection
DKS-8-ON-OFF	32753/On-Off (9)
DKS-8-PHOTO EYE-OFF	32742/Photo Eye-Off (9)
DKS-8-RUN-STOP	Run-Stop-Emergency
DKS-8-SERVICE-ON	32754/Service-On
DKS-8-SPEC-ON-SERV	32752/Special-On-Service

Car Signal Components

Toggle Key Switch Cylinders Non-Spring Return Key Removable "OFF" Position Only

S.E.E.S. #	O.E.M. #	Description
DKS-9	9759591, 35959	Standard key cylinder with two H-2395 keys
DKS-9A	9759797, 35979	Standard key cylinder with two H-2192 keys
DKS-9A-A	9703226	Key H-2192
DKS-9B-A	9703172	Key H-2399
DKS-9C-A	9703184	Key H-2448
DKS-10	9759610, 35961	Special key cylinder with two H-2304 keys
DKS-11	9859627, 35962	Special key cylinder with two H-2454 keys
DKS-12	9759803, 35980	Special key cylinder with two H-2237 keys
DKS-9B	9759815, 35981	Special key cylinder with two H-2399 keys

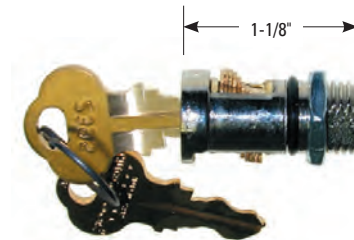

DKS-9



DKS-1B-1A

DKS-1B-2A



DKS-1B-1C

DKS-1B-1D

DKS-1B-1E

Toggle Switch

S.E.E.S. #	O.E.M. #	Description
DKS-1B-1A	9726287	Toggle Switch, SPDT, spring return
DKS-1B-2A		Toggle switch, DPST, 2 position ON/OFF
DKS-1B-1C	32631	Cam actuator 5/16" Slot for Toggle
DKS-1B-1D	35918	Washer, tab for bracket keyswitch
DKS-1B-1E	35344	Cam actuator 5/8" Slot for Toggle

Key Switch Assemblies Special Function

S.E.E.S. #	Description
DB-3E	Key Switch, black halo marked "DOOR HOLD", 2 position, key removable in ON only, H2395 key
DB-3F	Key Switch, red halo marked "RUN/STOP", 2 position, key removable in RUN only, H2395 key
DB-3J	Key Switch, black halo marked "OFF/ON", 2 position, removable in both, SEES. #2 key



DB-3F



DB-3A



DB-3B



DB-3G



DB-3H

Car Top Inspection Station Components

S.E.E.S. #	O.E.M. #	Description
DB-3A	9810857, 108150	Stop switch assembly, horizontal use, 1 Make 1 Break, red button 1-1/4" diameter, marked "PUSH STOP/PULL RUN"
DB-3B	9810985, 109888	Stop switch assembly, horizontal use, red button 1-1/4" diameter, marked "PUSH INSPECTION/PULL AUTO"
DB-3G	76703, 9743637	Light Switch for Car Top Inspection Station marked ON/OFF
DB-3H	76704	Receptacle for Car Top Inspection Station
MIS-147	109789	Lamp Guard, metal clamp on guard for Car Top Inspection Station



MIS-147

Car Signal Components



DB-10-



DB-11-

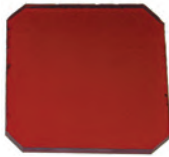

DB-12B



DB-69



DB-12



DB-59

Lighting

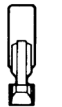

Fig. 1



Fig. 2



Fig. 3



Fig. 4



Fig. 5

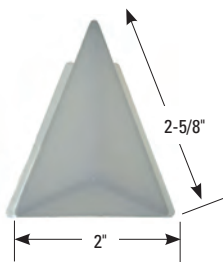

Fig. 6

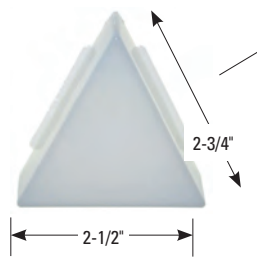

Fig. 7

■ This is a partial listing of Dover lamps. Additional lamps, including LED options, are listed in the Lighting Section.



DB-9



DB-9A

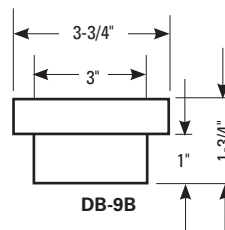

DB-9B-A



DB-9B-A

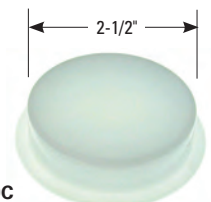

DB-9C

S.E.E.S. #	O.E.M. #	Description
DB-10-	9724-series	Position indicator lens , 1-5/8" square white lens with black character. Specify marking, i.e. DB-10-UP ARROW
DB-11-	9825-series	Position indicator lens , inclined white lens with black character. 1-3/8" height, 1-5/16" wide. Specify marking, i.e. DB-11-B
DB-12	9872097, 9863503	Lamp housing for position indicator, used with DB-52E
DB-52E	9851975, 35197	Lamp holder used with DB-12 for PSB type lamps
DB-12A	9863515, 76351	Lens , white frosted, for P.I., 1-9/16" square
DB-12B	9863527, 76352	Lens , red, for P.I., 1-9/16" square
DB-12C	9863539, 76353	Lens , green, for P.I., 1-9/16" square
DB-59	9719532	Fire Hat Jewel Assembly Square - Red Bezel 24V
DB-69	9724400	Divider for DB-11 position indicator

Lamps

Fig.	S.E.E.S. #	O.E.M. #	Lamp Description
1	ML-1	9769377, 76937	120 PSB
1	ML-3	9871664, 77167	48 PSB
1	ML-5	9871688, 77168	24 PSB
2	ML-57	9727190, 107189	#657, 28V
2	ML-93	A493L6	#161, 14V
3	ML-108	9721769, 175AA1	#85, 28V
4	ML-18	32462	6S6/120V
4	ML-15	32463	10S6/ 250V
5	ML-90	32464	25T8C, 120V
6	ML-67	32461	T4-1/2, 120V
7	ML-31	108248, 9782485	#503, 5.1V

Lantern Lenses

S.E.E.S. #	O.E.M. #	Description
DB-9	9863552	Arrow , for hall lantern signal. White arrow manufactured in durable Lexan
DB-9A	124081, 9722129	Hall lantern arrow , 2-3/4" x 2-1/2" white triangular arrow has smooth surface, mounting tabs hold it securely in place
DB-9B	138107	Lantern lens , 3-3/4" diameter, white frosted round lens
DB-9B-A		Lantern lens , 3-3/4" diameter 2" w
DB-9C	9730205	Lantern lens , 2-1/2" diameter
DB-9D	61491	Cab Fixture , Lens, Arrow

Lamp Holders

S.E.E.S. #	O.E.M. #	Description
DB-29	9727152, 138AD1	Lamp holder assembly for ML-108 lamp
DB-52	9772509, 770AE1	Lamp holder for ML-108 lamp
DB-52A	9711892, 9724710	Lamp holder assembly with resistor 1.2K, for P.I., Hall Station
DB-52B		Lamp holder assembly, same as above but without resistor
DB-52C	9778147, 108149	Lamp holder assembly with resistor for ML-93 & ML-57
DB-52D	9727164	Lamp holder assembly, same as above but without resistor
DB-52E	9851975, 35197	Lamp holder for PSB lamps



DB-52



DB-52E



DB-52A



DB-52C

Car Signal Components

Hall Station Assemblies

S.E.E.S. #	O.E.M. #	Description
DB-15A	176AL1	Terminal hall station assembly complete, Stainless steel plate, 9" x 3-1/2", complete with pushbutton module. Single white square button assembly and directional arrow.
DB-15A-1	9832646	Stainless steel plate, single rectangular opening 1-1/4" x 2-1/2"
DB-15A-1A		Terminal Hall Plate, 1.25" Square Hole, with studs
DB-15A-1B		Terminal Hall Plate, 1.25" Square Hole, with vertical studs
DB-15AE		Terminal Hall Station, Extended 11.75" x 3.375" Single Hole
DB-15B	176AL5	Intermediate hall station assembly complete, Stainless steel plate, 9" x 3-1/2", complete with two white square button assemblies and directional arrows.
DB-15BE		Intermediate Hall Station, Extended 11.75" x 3.375" Double Hole
DB-15B-1	9832658	Stainless steel plate, 9" x 3-1/2", double rectangular opening 1-1/4" x 2-1/2" each
DB-15C		Rear box cover, Galv Steel H 8.125" x W 2.5"
DB-15D	9828369	Hall Plate, Terminal with Fire Service PH1, 12" x 3.5"
DB-15D-1		Hall Plate, Terminal 3 Hole, 12" x 3.5"
DB-58	9780439	Impulse Fixture



DB-15A

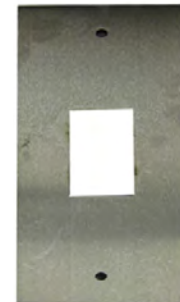

DB-15A-1



DB-15AE



DB-15B



DB-15BE



DB-15B (rear shot)



DB-15B-1



DB-15C



DB-15D

Car Signal Components

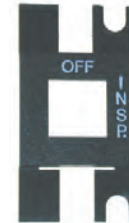
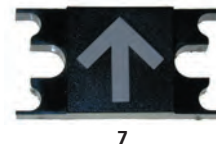
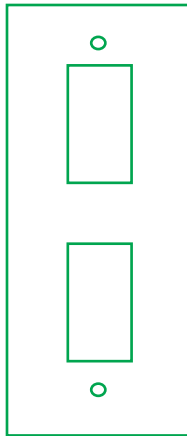

DB-44-1



DB-44-BLANK



DHDW-002

■ Items 1-6 are for the older style pushbutton assembly and are sold separately. Items 2, 5, 6, 13-17 are for the newer style pushbutton assembly and are sold separately and as a complete assembly, see below DB-77A, DB-77B and DB-77C.

Hall and Car Station Components

Item	S.E.E.S. #	O.E.M. #	Description
1	DB-16	9891717, 171AE1	Switch, 2 pole pushbutton switch
2	ML-108	9721769, 175AA1	Lamp, 28V, #85
3	DB-21	171AG1, 9818443	Clear cap
4	DB-22	9851288, 129AB1	Bracket, mounting
5	DB-42	9893209, 130AA1	Target lens
6	DB-43	9822690, 128AB1	Bezel, BLACK, 1-1/4" x 1-1/4"
	DB-43A	9822707, 128AB2	Bezel, BLUE, 1-1/4" x 1-1/4"
	DB-25	9822719, 128AB3	Bezel, RED, 1-1/4" x 1-1/4"
	DB-44-		Spacer, 1.25", square, specify marking
7	DB-44-	9893933, 131AE5	Spacer, arrow Horizontal mount, for hall
	ARROW HALL		
	DB-44-	9719398, 138200	Spacer, arrow Vertical mount, for car
	ARROW CAR		
	DB-44-1	9798160	Spacer, 1.25" square, marked #1
	DB-44-8		Spacer, 1.25" SQ Marked #8
	DB-44-9		Spacer, 1.25" SQ Marked #9
	DB-44-10		Spacer, 1.25" SQ Marked #10
	DB-44-11		Spacer, 1.25" SQ Marked #11
	DB-44-12		Spacer, 1.25" SQ Marked #12
	DB-44-14		Spacer, 1.25" SQ Marked #14
	DB-44-STAR-1	9798158	Spacer, 1.25", square, marked "Star 1"
	DB-44-BLANK		Spacer, 1.25" square, blank
8	DKS-13, DKS-14		Key Switch (See "Key Switches", page 550 for complete listing)
9	DKS-24-		Bezel, Key switch, (See "Bezels", page 550 for complete listing)
10	DB-57	200AA1	Fastener, Faceplate 10-24 x 2 Button head screw
11	DB-23	140809	Clip, spring
12	DB-73	129BC1	Housing, for pushbutton
13	DB-74	232AA1	Housing, for micro switch
14	DB-75	228AF1	Actuator for pushbutton
15	DB-76	780AB1, 780AD1	Spring
16	DB-52	9772509, 770AE1	Lamp socket
17	DKS-58	131AF1	Spacer
	DHDW-002	9752018	Speed Nut, Signal Fixtures #10-24 "Emerg Exits"

Pushbutton Assemblies

Item	O.E.M. #	Description
DB-77A	9817219, 171AV1, 171AV4	Pushbutton assembly complete, with two micro switches, black bezel
DB-77A-LED-R		Pushbutton assembly, Red LED with 2 Micro Switches
DB-77A-LED-O		Pushbutton assembly, Orange LED with 2 Micro Switches
DB-77A-LED-G		Pushbutton assembly, Green LED with 2 Micro Switches
DB-77A-LED-W		Pushbutton assembly, White LED with 2 Micro Switches
DB-77A-LED-Y		Pushbutton assembly, Yellow LED with 2 Micro Switches
DB-77A-VAN-A	9817219-VANDAL	Pushbutton assembly, Vandal Proof with 2 Micro Switches, Alum Finish
DB-77A-VAN-B	9817219-VANDAL	Pushbutton assembly, Vandal Proof with 2 Micro Switches, Black Finish
DB-77A-VAN-B-BLED		Pushbutton assembly, Vandal Proof with 2 Micro Switches, Black Finish, Blue LED
DB-77A-VAN-B-RLED		Pushbutton assembly, Vandal Proof with 2 Micro Switches, Black Finish, Red LED Bulb
DB-77A-VAN-B-KIT		Vandal Upgrade Kit, Black Bezel with Retaining Brackets
DB-77A-VAN-R	9817219-VANDAL	Pushbutton assembly, Vandal Proof with 2 Micro Switches, Red Finish
DB-77A-VAN-R-KIT		Vandal Upgrade Kit, Red Bezel with Retaining Brackets
DB-77A-VAN-BLU	9817219-VANDAL	Pushbutton assembly, Vandal Proof with 2 Micro Switches, Blue Finish
DB-77A-VAN-BLU-KIT		Vandal Upgrade Kit, Blue Bezel with Retaining Brackets
ML-108-LED-W		Lamp, #85 LED White
ML-108-LED-O		Lamp, #85 LED Orange
ML-108-LED-R		Lamp, #85 LED Red
ML-108-LED-Y		Lamp, #85 LED Yellow
DB-77B	171AV2, 171AV5	Pushbutton assembly complete, same style as DB-77A but with BLUE bezel
DB-77C	171AV3	Pushbutton assembly complete, same style as DB-77A but with RED bezel
DB-77E		Pushbutton assembly complete, Old Style with 2 Micro-switches, small tabs
DB-77F	9817190	Pushbutton assembly complete, New Style with 1 Micro Switch



DB-77A

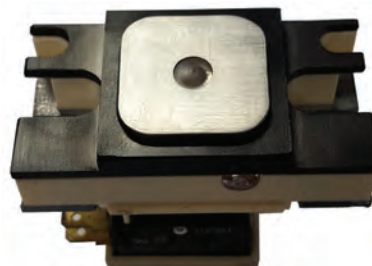

DB-77A-VAN-B



DB-77B



DB-77C

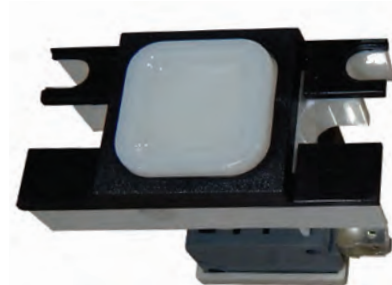

DB-77F

Car Signal Components

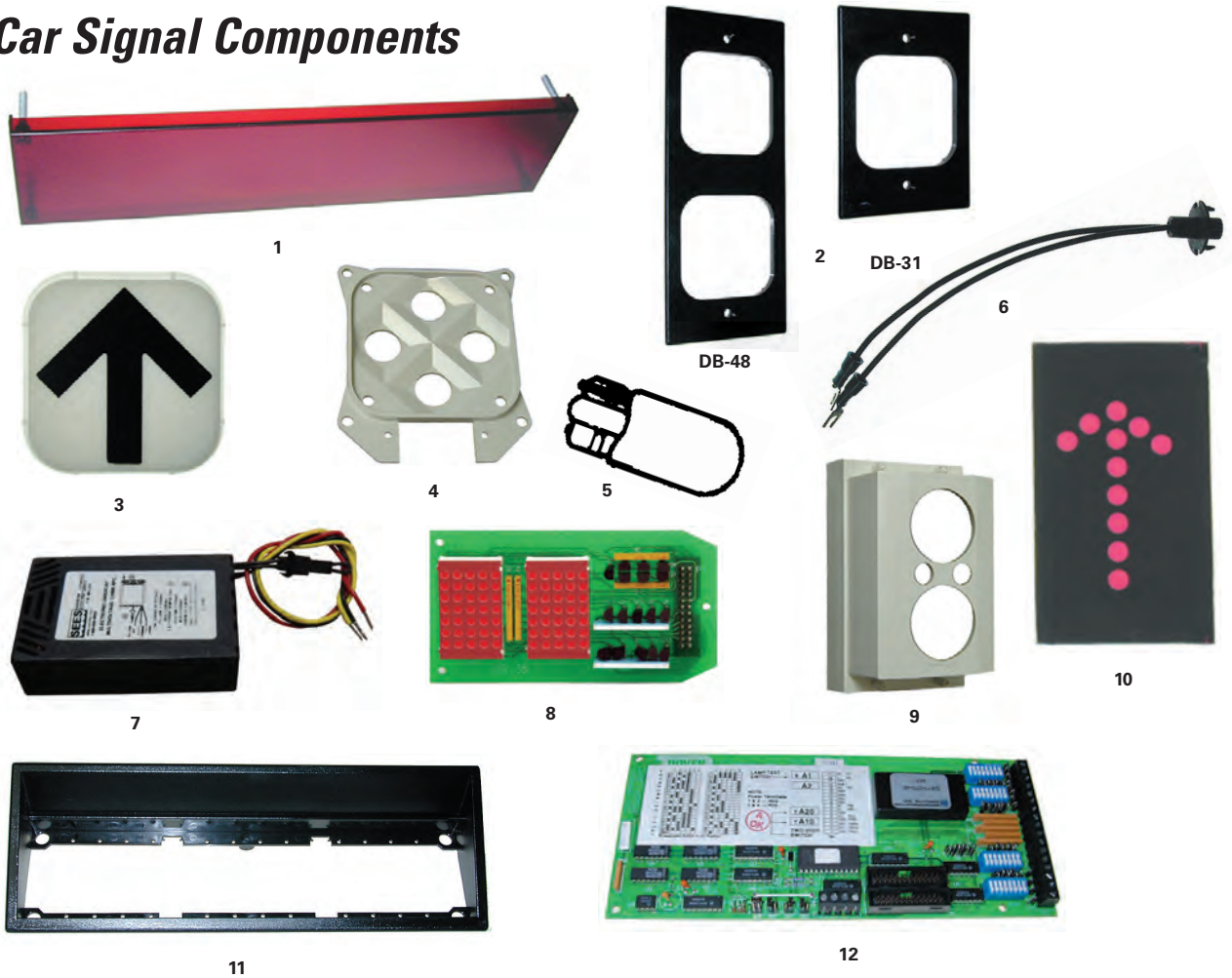

Hall Lantern and Position Indicator Assemblies

Item	S.E.E.S. #	O.E.M. #	Description
1	DB-30	9730618, 130AC2	Red Lens, 10" x 2-3/4", for position indicator
2	DB-31	9741215, 141AA1	Face Plate, 5" x 3-3/4", Jamb arrow frame, single
	DB-31-MF		Face Plate for Arrow, Mirrored Finish 6-3/4" x 5-1/4"
	DB-48	9741318, 141AA2	Face Plate, 9-1/4" x 3-3/4", Jamb arrow frame, double
	DB-48-MF		Frame, Jamb for Double Arrow, Mirrored Finish 10-3/4" x 5-1/4"
3	DB-32	9730266, 130AD2	Lantern Lens, arrow, 2-3/4" x 2-3/4" face, 3" square base
4	DB-33	134AD1, 9734144	Reflector, lantern lens
5	ML-108	9721769, 175AA1	Lamp, 28V
6	DB-29	9727152	Lamp Socket, Impulse lamp holder
7	MIS-CH1	9775717, 177A1	Chime, hall lantern, 24-130 VAC/DC. Non-polar
8	DB-35	9835878, 178AC1	PC Board, position indicator display board, dual
9	DB-36	134AA1	Reflector
10	DB-36A-	130AG1-24	Dot Film for discrete P. I., Specify marking, i.e. DB-36A-ARROW, 1.256" x 1.975"
11	DB-20	9832336, 138AA1, 138AA2	Inclined Housing
	DB-37	9713232, 178AD2	PC Board, Power board, logic, 24V
12	DB-38	9713244, 178AD1	PC Board, Power board, logic, 48V
	DB-CLS-001H		Car Lantern Assembly, Up Arrow - Red, Down Arrow - Green 28V Incandescent
	DB-CLS-002H		Car Lantern Assembly, (2) Arrows - Red 28V Incandescent

Car Signal Components

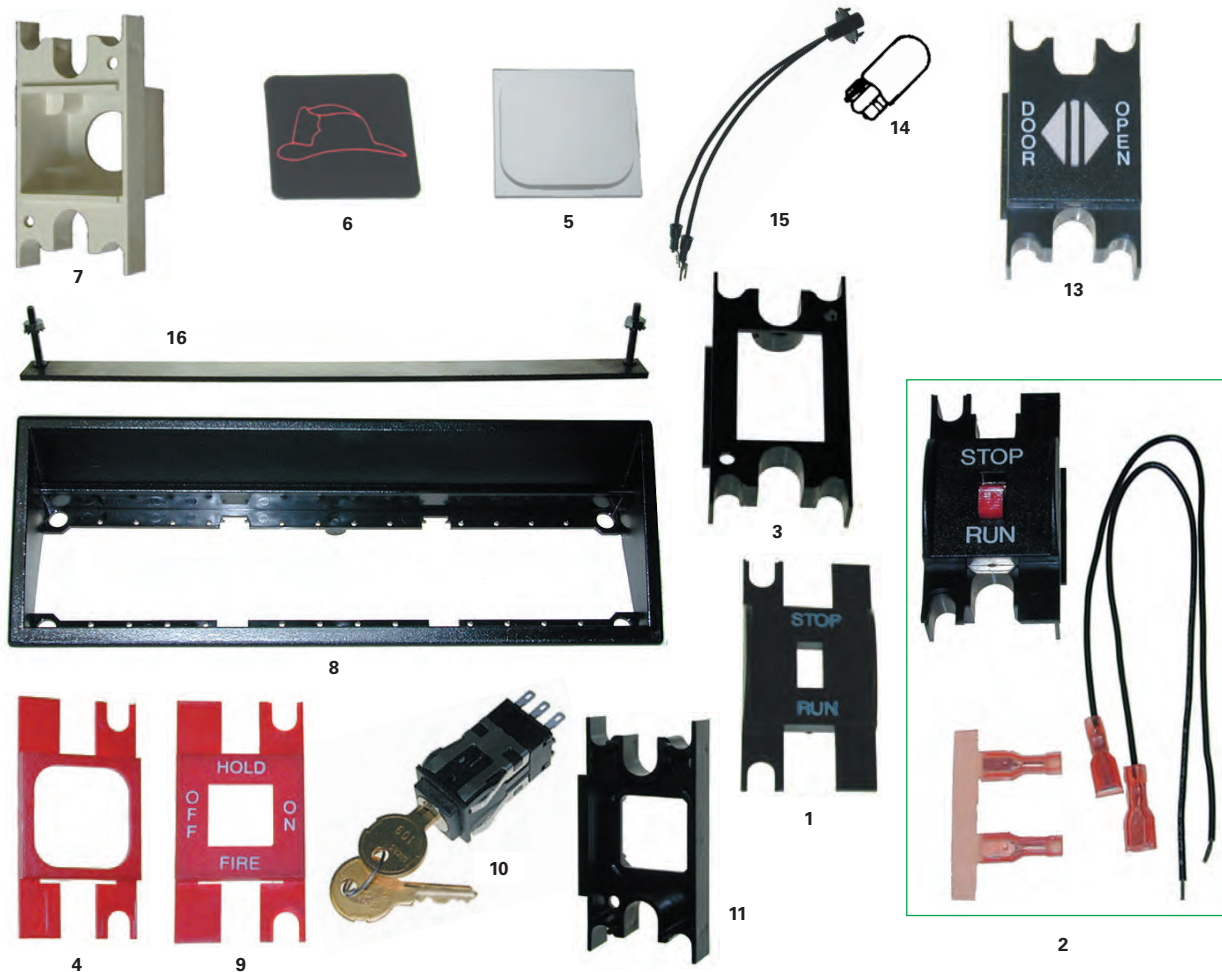

Spacer, Fire Jewel and Switch Assemblies

Item	S.E.E.S. #	O.E.M. #	Description
1	DB-17 DB-17A	128AA2, 9728119 128AA3	Bezel, Run-Stop, face 1-1/4" x 1-1/4" Bezel, blank
2	DB-18	171AC2, 9810183, 9810158	Switch Assembly, DPST paddle switch, includes bezel
3	DB-19	129AA1	Mounting bracket
4	DB-25	128AB3, 9822719	Bezel, red, Fire Service
5	DB-26	130AB1	Lens, 1" square face, base 1.09" square, clear
6	DB-27A	130AF3	Lens, for Fire Service, with symbol of fire fighter's hat
7	DB-28	134AB1	Reflector
8	DB-20	138AA1, 138AA2	Inclined Housing
9	DKS-24-		Bezel, keyswitch (see listing next page for markings)
10	DKS-13, DKS-14		Key switch, (see listing next page)
11	DB-24	9851276, 129AC1	Bracket
13	DB-44-	132AE-	Spacer, 1.25" wide, black with white raised character with braille below specify marking, i.e. DB-44-OPEN (shown)
16	DB-70	129AF1	Hold Down Strip, Stainless, 10" L

Car Signal Components

Spacer, Fire Jewel and Switch Assemblies



DKS-13

Item	S.E.E.S. #	O.E.M. #	Description
	DB-44-FIRE-OPER	9805059, 131AE29	Spacer , Fire Fighter Operation
	DB-44-FIRE-INSERT	9805060, 131AE30	Spacer , "Insert Fire Key and Turn.."
14	ML-108	175AA1, 9721769	Lamp , 28V, #85
15	DB-29	138AD1, 9727152	Lamp housing
16	DB-70	129AF1	Hold down strip , stainless, 10" long

Key Switches

S.E.E.S. #	O.E.M. #	Key #	Description
DKS-13	171AA1, 9753140	5074, 109	2 Key positions , CTR, CW removeable key in both positions, suitable for PHOTO EYE, INDEP., EMERG. SVC., & LIGHT switches. ■ Switch is now furnished with 109 key
DKS-13A	9710279	5074	Key , replacement keys for "old style" switch
DKS-13B	9720091	109	Key , replacement keys for "new style" switch
DKS-14	171AA7	110	3 Key positions , CCW, CTR, CW key removable in CTR and CW positions, hall use, suitable for FIRE BYPASS. ■ Switch is now furnished with 110 key
DKS-14A	9710267	5027	Key , replacement keys for "old style" switch
DKS-14B		110	Key , replacement keys for "new style" switch
DKS-15A	9710255	5154	Key , replacement keys for "old style" switch
DKS-15B		107	Key , replacement keys for "new style" switch
DKS-16	171AA13	5027, 110	2 Key positions , CTR, CW key removable in both positions, suitable for EMERGENCY POWER. ■ Switch is now furnished with 110 key
DKS-18A	9710334	5140	Key , replacement keys for "old style" switch
DKS-18B	9720133	106	Key , replacement keys for "new style" switch
DKS-21	171AA2, 9753102	5140, 106	2 Key positions , CTR, CW key removable in CTR position only. INSPECTION. ■ Switch is now furnished with 110 key
DKS-25	9720133	H8020	Key

■ Bezel 1-1/4" square face with 5/8" x 5/8" square hole. Bezel markings are listed in the order that they appear, the first marking is at the 12 o'clock position, subsequent markings are in the 3 o'clock position, following clockwise to the next position (6) unless otherwise noted. i.e. see DKS-24-INDEPENDENT "Off" (12) "Serv" (3), "Indep" (9)

■ Additional markings available by Special Order.



DKS-24-INSPECTION

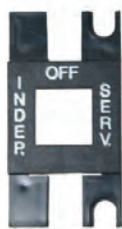

DKS-24-INDEPENDENT

Key Switch Bezels

S.E.E.S. #	O.E.M. #	Bezel Marking/Description
DKS-24-BLANK BLACK	128AC1	Bezel , blank, black
DKS-24-BLANK RED	128AC2	Bezel , blank, red
DKS-24-FIRE-BYPASS	128AC3	Off/On/Fire/Bypass , red bezel, hall use
DKS-24-FIRE-HOLD	128AC4	Hold/On/Fire/Off , red bezel, car use
DKS-24-INSPECTION	128AC5	Off/Insp , black bezel
DKS-24-INDEPENDENT	128AC6	Off/Serv/Indep (9) , black bezel
DKS-24-EMERGENCY	128AC7	Off/Serv/Emerg (9) , black bezel
DKS-24-OFF-ON	128AC11, 9822628	Off/On , black bezel for vertical car use
DKS-24A-OFF-ON	128AC12, 9822630	Off/On , black bezel for horizontal hall use
DKS-24-LIGHT	128AC13, 9822641	Light/Off , black bezel
DKS-24-LIGHT-FAN	128AC14, 9822653	Off/Fan/Light (9) , black bezel
DKS-24-HIGH-LOW-FAN	128AC15, 9822655	Off/High/Fan/Low , black bezel
DKS-24A-FIRE-BYPASS		Bezel , Red "Bypass-Off-On" Square, Horizontal

Car Signal Components

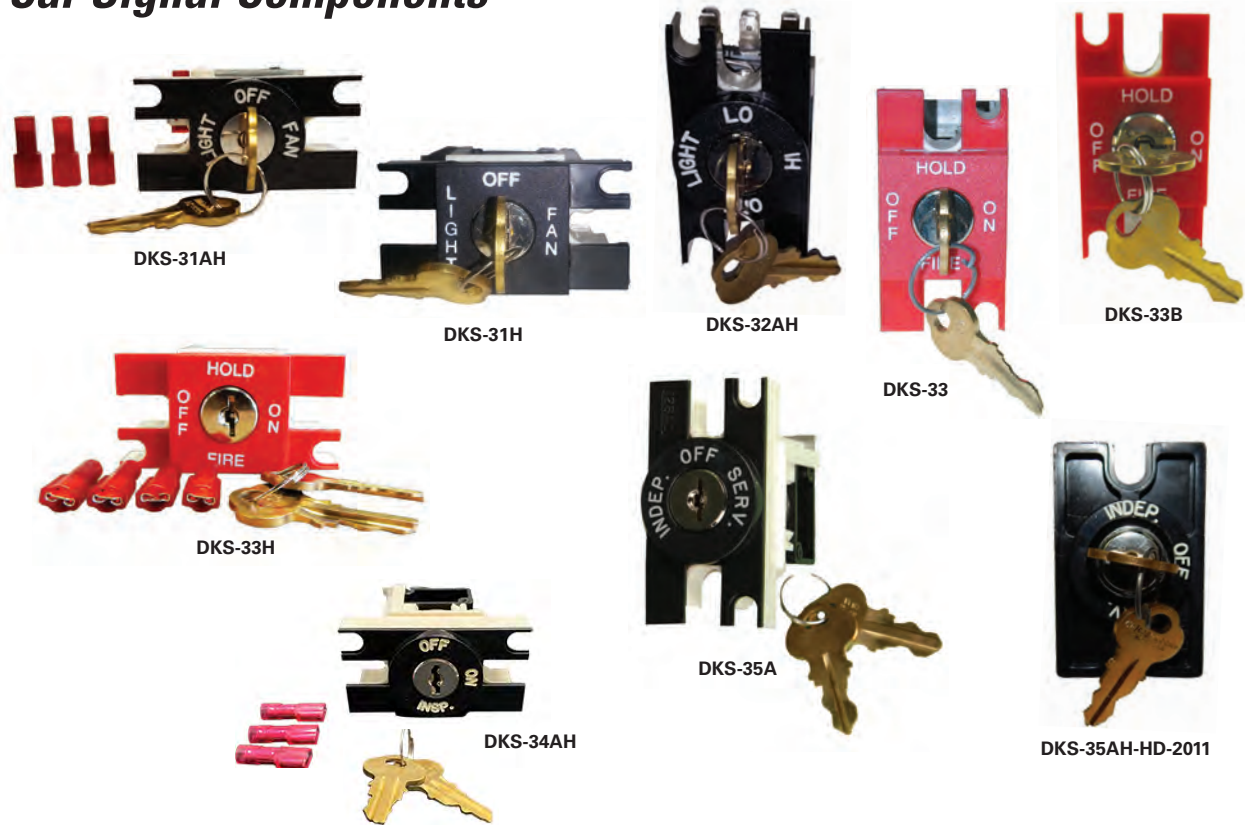

Key Switches

S.E.E.S. #	O.E.M. #	Key #	Marking/Description
DKS-30	9746006, 171AR1	H2395	Light/Off, 2 Position, Removable both, Vertical
DKS-30A		H2395	Key Switch Assembly, Light/Off, Round Vertical
DKS-30A-L203		L203	Key Switch Assembly, Light/Off L203, Round Black
DKS-31	9746018, 171AR2	H2395	Off/Fan/Light (9), 3 Position, Removable all, Vertical
DKS-31AH	9772935	H2395	Key Switch, Light/Fan, round, Horizontal
DKS-31AH-SEC		H2395	Key Switch, Sec-Off-Norm H2395 Round Black Horizontal, 3P, R3
DKS-31H		H2395	Key Switch, Light/Fan H2395 Square, Horizontal
DKS-32	9746020, 171AR3	H2395	Light/Lo/Hi/Off for Light and 2 Speed Fan, 4 Position, Removable all, Vertical
DKS-32H		H2395	KeySwitch, Light 2 Speed Fan, Square, Horizontal
DKS-32AH		H2395	KeySwitch, Light 2 Speed Fan, 4 Position, Round, Horizontal
DKS-33	9746031, 171AR4	H2389	Hold/On/Fire/Off for Car Fire Service, 3 Position, Removable all, Phase II, Vertical
DKS-33B		H2389	Key Switch Assembly, Car Fire Service, ON-ON-ON, Square Vertical
DKS-33BA		H2389	Key Switch Assembly, Car Fire Service, ON-ON-ON, Round, Vertical
DKS-33C		H2389	Key Switch, Fire Service PH2, Square Vertical, ON-ON-ON, 3 Pos Rmv2
DKS-33CA		H2389	Key Switch, Fire Service PH2, Round Vertical, ON-ON-ON, 3 Pos Rmv2
DKS-33H		H2389	Key Switch, Car Fire Service PH2, H2389, Square, Horizontal
DKS-34	9746043, 171AR5	H1846	Off/Inspection, 2 Position, Removable both, Vertical
DKS-34A		H1846	Key Switch Assembly, inspection, round
DKS-34AH		H1846	Key Switch Assembly, inspection H1846 Round, Horizontal
DKS-35	9746055, 171AR6	H2395	Off/Serv./Indep (9), 2 Position, Removable both, Vertical
DKS-35A		H2395	Key Switch, Independent Service, round, Vertical
DKS-35AH	9719775	H2395	Key Switch, Independent Service, round, Horizontal
DKS-35AH-HD		H2395	Key Switch, Independent Service, round, Horizontal, Heavy Duty
DKS-35AH-HD-2011		H2011	Key Switch, Independent Service H2011, Round, Horizontal, Heavy Duty, 2P2R
DKS-35AV-HD-2011		H2011	Key Switch, Independent Service H2011, Round, Vertical, Heavy Duty, 2P2R
DKS-35BV-HD-1848		H1848	Key Switch, Independent Service 1848 Sq, Vert, Heavy Duty, 2P2R

Key Switches

S.E.E.S. #	O.E.M. #	Key #	Marking/Description
DKS-36	9746067, 171AR7	H2395	Off/Eye/Photo (9), 2 Position, Removable both, Vertical
DKS-36AH		H2395	Key Switch, "Photo Eye", Round Horizontal
DKS-37	9746079, 171AR8	H2395	Off/Serv/Emergency (9), 2 Position, Removable both, Vertical
DKS-37H	9746079 Horiz	H2395	Keyswitch, "EMERG. SERVICE" Horizontal
DKS-38	9746080, 171AR9	H2395	Off/Hold/Door (9), 2 Position, Removable in Off only, Vertical
DKS-39	9746092, 171AR10	H1848	Off/On, for Car Call Lockout, 2 Position, Removable both, Vertical
DKS-39-HD		H1848	Key Switch, for Car Call Lockout, H1848
DKS-39-HD-L206		L206	Key Switch, Car Lockout L206 2P, R1 (Off/On), Heavy Duty, Vertical, Square
DKS-39-HD-#2		SEES #2	Key Switch, Car Call Lockout, SEES #2 Key 2P, 2KP (Off/On), Heavy Duty, Vet Sq
DKS-39-HD-#3		SEES #3	Key Switch, Car Call Lockout, SEES #3 Key 2P, 2KP (Off/On), Heavy Duty, Vet Sq
DKS-39A-HD		H1848	Key Switch, Car Call Lockout H1848 (Off/On) Heavy Duty, Vertical, Round
DKS-39-HD-A03		A03	Key Switch, Car Call Lockout, A03 Key (Off/On), Heavy Duty, Vertical, Square
DKS-41-HD-2395		H1846	Key Switch, Car Call Lockout H1846 (Off/On), Heavy Duty, Vertical Square
DKS-40	9746109, 171AR11	H1848	Off/On, for Car Call Register, 2 Position, Spring return, Vertical
DKS-40A		H1848	Key Switch, Car Call Register
DKS-40A-HD		H1848	Key Switch, Car Call Register Round, Vertical, Heavy Duty, H1848
DKS-40AH-HD		H1848	Key Switch, Car Call Register Round, Horizontal, Heavy Duty, H1848
DKS-40B-HD		H2395	Key Switch, Car Call Register Round, Vertical, Heavy Duty, H2395
DKS-40C-HD		H2395	Key Switch, Car Call Register Square, Vertical, Heavy Duty
DKS-40-HD-2011		2011	Key Switch, Off-On, 2 Pos Mom, Square, Black Vertical, Heavy Duty, 2011
DKS-41	9746110, 171AR12, 9739713	H1848	Off/On, for Hall Register, Terminal, 2 Position, Spring return, Horizontal
DKS-41A		H1848	Off/On, for Hall Register, Terminal, Round
DKS-41-DES1		DES-1	Key Switch, Term Hall Reg DES-1 Key
DKS-41A-DES1		DES-1	Key Switch, Term Hall Reg, Round Horizontal DES-1 Key
DKS-41-HD		H1848	Term Hall Reg. Square, Horizontal, Heavy Duty, 2 Position Mom
DKS-41-HD-1846		H1846	Key Switch, Term Hall Reg. Square, Horizontal
DKS-41-HD-2395		H2395	Key Switch, Off-On Square Horizontal Heavy Duty, H2395, 2 Position Mom
DKS-41A-HD		H1848	Term Hall Reg. Round, Horizontal, Heavy Duty, 2 Position Mom
DKS-41B-HD		H2395	Term Hall Reg. Round, Horizontal, Heavy Duty, 2 Position Mom
DKS-41C-HD		SEES#3	Key Switch, Term Hall Reg. Round, Horizontal, Heavy Duty, SEES#3, 2 Pos Mom
DKS-41V		H1848	Key Switch, Term Hall Reg H1848 Vertical, Square, Off-On
DKS-42	9746122, 171AR13	H1848	Off/Dn/Up (9), for Hall Reg., Intermediate, 3 Position, Spring return to Off, Horizontal
DKS-42V		H1848	Key Switch, Hall Reg. Intermediate Vertical
DKS-42-HD		H1848	Key Switch, Hall Reg Intermed 3 Position, MOM Horizontal, H1848 Heavy Duty
DKS-42A-HD		H1848	Key Switch, Hall Reg Intermed, Round Black 3Pos MOM Horiz, H1848 Hvy Duty
DKS-43	9746134, 171AR14	H1848	Off/On, for Hall Call Lockout, 2 Position, Removable both, Horizontal
DKS-43-HD	9746134-HD	H1848	Off/On, for Hall Call Lockout, Heavy Duty, 2 Position, 2KP, Horizontal
DKS-43A-HD		H1848	Keyswitch, Hall Lockout, Heavy Duty 2P, 2KP H1848 Key, Black Round Horiz
DKS-43-HD-1846		H1846	Keyswitch, Hall Lockout Off/On Heavy Duty, 2P/2KP, Horiz H1846
DKS-43-HDV-2395		H2395	Keyswitch, all Lockout Off/On Heavy Duty, 2P/2KP, Vert H2395
DKS-43A-HD-2395		H2395	Keyswitch, Hall Lockout Off/On Heavy Duty, 2P/2KP, Round, Horizontal, H2395



DKS-39-HD



DKS-40



DKS-40AH-HD



DKS-41



DKS-41-HD



DKS-41A-HD



DKS-41B-HD



DKS-42V

DKS-40C-HD

Key Switches

S.E.E.S. #	O.E.M. #	Key #	Marking/Description
DKS-44	9746146, 171AR15	H2395	On/Lobby (9) , 2 Position, Removable both, Horizontal
DKS-45	9746158, 171AR16	H2389	Off/Power/Emergency (9) , 2 Position, Removable both, Horizontal
DKS-46	9746160, 171AR17	H2389	Off/On/Fire/Byp. , for Hall Fire Service, PHI, 3 Position, Removable 2, Horizontal
DKS-46A		H2389	Key Switch , for Hall Fire Service, round
DKS-46B		H2389	Key Switch , Fire Service, Round, Horizontal, 2P/R2 H2389 Off-On
DKS-46C		H2389	Key Switch , Fire Service, Square, Vertical, 2P/R2 H2389 Off-On
DKS-46AR		H2389	Key Switch , Hall Fire Service, Round, Horizontal, Reset-Off-On
DKS-46R		H2389	Key Switch , Hall Fire Service, Square, Horizontal, Reset-Off-On
DKS-47	9746171, 171AR18	H1846	Off/Up/Hwy.Acc./Dn , 3 Position, Spring return to Off, Horizontal
DKS-47A		H1846	Key Switch , Hoistway Access, 48V, round
DKS-47A-2395		H2395	Key Switch , Rnd Black Hoistway Access Up-Off-Dn Hwy Access, 3Pos MOM
DKS-48	9746183, 171AR20	H2389	Off/On/Fire/Bypass , red, for Hall Fire Service, 3 Position, Removable 2, Vertical
DKS-48A		H2389	Key Switch , for Hall Fire Service, Vertical
DKS-48R		H2389	Key Switch , Fire Service PHI Vertical, Square, Reset-Off-On
DKS-48RA		H2389	Key Switch , Fire Service PHI Vertical, Round, Reset-Off-On
DKS-48-NY		3502	Key Switch , Fire Service PHI Vertical, Square, with 3502 Key
DKS-49	9746195, 171AR21	H1846	Stop/Run , for In Car Stop, 2 Position, Removable both, Vertical, (Square Bezel)
DKS-49A	138530, 9715952	H1846	Stop/Run , for In Car Stop, 2 Position, Removable both, Vertical, (Round Bezel)
DKS-49B	9735112	H2011	Key Switch , car Run/Stop 2 Position remove in both, Round, Vertical
DKS-49C		SEES#2	Key Switch , car Run/Stop 2Pos Remove 2, Square, Vertical
DKS-50	9746201, 171AR22	H1846	Off/Access , for In Car Access, 2 Position, Removable both, Vertical
DKS-50AH	H2395		Key Switch , In-Car Access Round Black Horizontal H2395, Off-Access
DKS-61	780ACI		Spring , return
DKS-74B	9845641	H1846	Cylinder Lock , H-1846, DKS-74 & DKS-74A
DKS-76	660AP1	H2011	Key plug for H2011 key Emergency Stop
DKS-78-LOCKOUT-SP			Key switch Special , 2 positions, Rmv2
DKS-79V		L206	Key Switch , Code Blue, Square Vertical Black, 2 Pos, Rmv1, (Off-Code Blue)
DKS-79H		L206	Key Switch , Code Blue, Square Horizontal Blk, 2Pos, Rmv1, (Off-Code Blue)
DKS-79AH		L206	Key Switch , Code Blue, Round Horizontal Black, 2 Position, R1, (Off-Code Blue)
DKS-80HR		H2395	Key Switch , Code Blue, Round Horizontal Black, 2 Position, R1, (Code-On-Blue)
DKS-100	9932057		Key Switch , Up and Down
DKS-200	9721757, 2174-2	2165	Cylinder , Key Switch 2174-2, E Lock, Removable 2
DKS-202	9776801		Key , for Fire Service #SC1000
DKS-203		H2389	Key switch , Fire Phase 1, 3 Position R2, Key H2389
DKS-204		H2389	Key switch , Fire Phase 2, 3 Position R2, Key H2389

- Bezel markings are listed in the order that they appear, the first marking is at the 12 o'clock position, subsequent markings are in the 3 o'clock position, following clockwise to the next position (6) unless otherwise noted. For examples, see DKS-31 "Off" (12) "Fan" (3), "Light" (9)
- Additional markings available by Special Order.



DO YOU KNOW FEO?

ASME A17.1 2007 AND UP 2.78.8 SWITCH KEYS

The key switches required by 2.27.2 through 2.27.5 for all elevators in a building shall be operable by the **FEO-K1 KEY**. The keys shall be Group 3 Security. A separate key shall be provided for each switch. These keys shall be kept on the premises in a location readily accessible to firefighters and emergency personnel...

...The key shall be coded "FEO-K1."



FEO-K1
ORDER YOUR
FIRE SERVICE
KEY TODAY!

FOR ALL
FEO PARTS SEE
PAGES 346-354
IN THE
SEES CATALOG

FIRE SERVICE / FEO KEY SWITCH PARTS

SEES carries all elevator brands

<p>FEO-K1</p>	<p>UNIVERSAL</p>	<p>TRADITIONAL</p>	<p>IMPULSE</p>	<p>INNOVATION</p>	<p>DOVER</p>
<p>CYLINDER</p>	<p>GAL</p>	<p>ADAMS</p>	<p>KONE</p>	<p>SCHINDLER</p>	<p>OTIS</p>



Always Smooth Sailing

@SEESinc
 SEESinc.com/blogs
 SEESinc



**SOUTHERN ELEVATOR
& ELECTRIC SUPPLY**

Car Signal Components

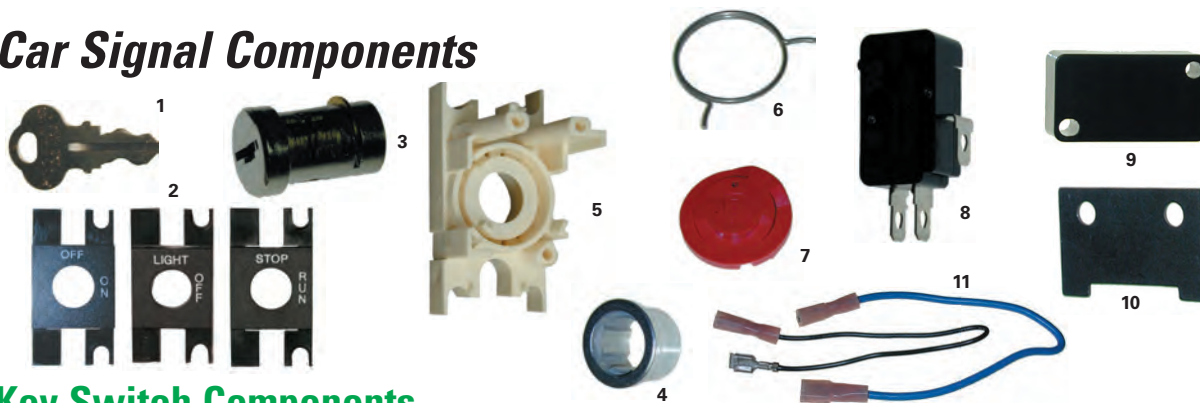

Key Switch Components

Item	S.E.E.S. #	O.E.M. #	Description
1	DKS-3A	9703135, 103105	Key , H2395
	DKS-4A	9703196, 103107	Key , H2389
	DKS-52A-	128AD-	Bezel , 1-1/4" Square face with 5/8" dia. hole, (specify marking & orientation)
	DKS-52B-	138174, 138485	Bezel , 1-1/4" diameter Round face with 5/8" dia. hole (specify marking & orientation)
	DKS-52BA-		Bezel , Round, Black, Horizontal, Specify Markings i.e. DKS-52BA-ACC, shown
	DKS-52BA-SPECIAL		Bezel , Round, Black, Horizontal, special marking
	DKS-52BA-ACC		Bezel , Off-On Hwy Acc, Round Black Horizontal Mt
2	DKS-52-	128AD-	Bezel , 1-1/4" Square face with 5/8" dia. hole, shown (specify marking & orientation)
4	DKS-53	662AA1	Lock , Barrel
	DKS-54	638AC1	Pin , 1/16" x 1/2"
5	DKS-55	129AY1	Bracket , mounting
7	DKS-56	228AA1	Cam for keyswitch , Black
	DKS-56A	228AA2	Cam for keyswitch , Clear
	DKS-56B	228AA3	Cam for keyswitch , White
	DKS-56C	228AA4	Cam for keyswitch , Red
8	DKS-57A	171AP1, 9818431	Micro Switch , 100 Gram pressure sensitivity
9	DKS-58	131AF1	Spacer
	DKS-58A	638AA1	Pin , key switch connector
10	DKS-59	711AA1	Retainer
	DKS-60	780AB1	Spring , detent, for keyswitch
6	DKS-61	780AC1	Spring , return
11	DKS-62	900AB14	Jumper , 7", 2 wire
	DKS-63	900AD36	Jumper , 6", 1 wire
3	DKS-72	660AC1	Plug , Key, 1 slot, H2395 key
	DKS-73	660AC2	Plug , Key, 1 slot, H2389 key
	DKS-74	660AD1, 9845641	Plug , Key, 2 slot, H1846 key
	DKS-75	660AD2	Plug , Key, 2 slot, H1848 key
	DKS-76	660AP1	Plug , Key, 2 slot, H2011 key
	DKS-74A	9731064, 103106	Key , H1846
	DKS-74B	9845641	Cylinder Lock , H-1846, DKS-74 & DKS-74A
	DKS-75A	9703391, 148008	Key , H1848



DKS-52A-OFF-ON



DKS-52B-BLANK BLACK



DKS-52B-BLANK RED



DKS-52BA-ACC



DKS-54



DKS-60



DKS-63

DKS-64

S.E.E.S. #	O.E.M. #	Description
DKS-64	9738605	Cylinder DES-1 key
DKS-64A	9718308	DES-1 key
DKS-65	9738629	Cylinder DES-3 key
DKS-65A	9718321	DES-3 key
DKS-66	9738630	Cylinder DES-4 key
DKS-66A	9718333	DES-4 key
DKS-67	9738642	Cylinder DES-5 key
DKS-67A	9718345	DES-5 key

S.E.E.S. #	O.E.M. #	Description
DKS-68	9738654	Cylinder DES-6 key
DKS-68A	9718357	DES-6 key
DKS-69	9738666	Cylinder DES-7 key
DKS-69A	9718369	DES-7 key
DKS-70	9738680	Cylinder DES-9 key
DKS-70A	9718382	DES-9 key
DKS-71	9738691	Cylinder DES-10 key
DKS-71A	9718394	DES-10 key

Car Signal Components



1



DB-41-2100



DB-39

2

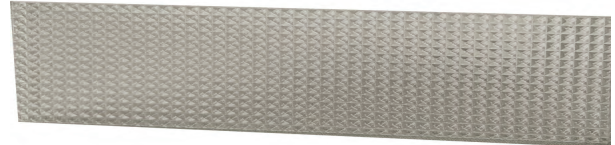

DB-90



3



5

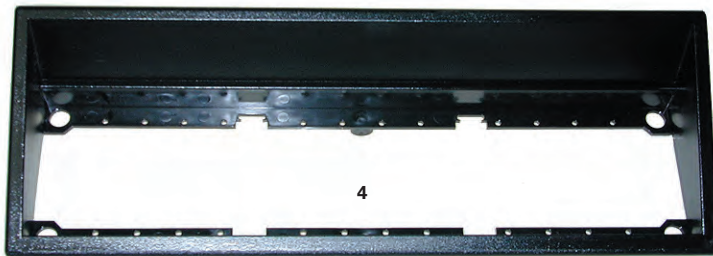

4



6

Emergency Light Components

Item	S.E.E.S. #	O.E.M. #	Description
1	DB-41	169AC12, 163AC24	Plate, blank, 10" x 2.44"
	DB-41-2000		Plate, 2000lb capacity lens
	DB-41-2100	9896820	Plate, 2100lb capacity lens
	DB-41-3000		Plate, 3000lb capacity lens
	DB-41-3500		Plate, 3500lb capacity lens
	DB-41-4500	9896879	Plate, 4500lb capacity lens
2	DB-39	130AC1	Clear lens, 10" x 2-3/4", for emergency light assembly
	DB-90	130AP1	Lens, old style Dover emergency light
3	DB-12	134AE1, 9872097	Reflector
4	DB-20	138AA1, 9832336	Inclined housing
5	DPC-37	118412, 9818420	PC board, emergency light printed circuit board, LED version
5	DPC-37A	9839720, 6300GD1	PC board, emergency light printed circuit board, new version to replace DPC-37
	ML-31	108248, 9782485	Lamp, 5.1V
6	DB-52B		Lamp holder
	MIS-194B	9880719	Battery, 7AH, 6V, replacement for emergency light



DB-49



DB-49B



DB-49C

S.E.E.S. #	O.E.M. #	Description
DB-49	168AA2, 9768117	Frame for telephone box, 10-1/2" W x 12-3/8" H
DB-49B	9846384, 168AA1	Handle for telephone box cover, black plastic handle, phone shaped for Braille use, 1-1/8" c/c mounting holes, 1.575" long
DB-49C	9766212	Magnetic Catch for phone box door
DB-49D	173AF2	Door , Stainless steel phone cabinet door, 10-1/2" x 12-1/2"
DB-50	9710619	Phone Jack Module , red, square, fire service
DB-50A		Phone Jack , red, round, horizontal, fire service
DB-50AV		Phone Jack , red, round, vertical, fire service
DB-50V	9710681	Phone Jack , red, square, vertical, fire service
DB-51	9885822	Phone Jack Module , fireman telephone for DB-50/50A
DB-60	169AV1, 9769249	Braille sheet consisting of an assortment of plastic self adhesive braille plates
MIS-T-100		Telephone box , stainless steel cover, 10" x 12.5", box 9" x 10.625"
MIS-TH-100		Replacement handle , for telephone box, aluminum, "PHONE"
MIS-TH-100-P	9846396	Replacement handle , for telephone box, plastic, "PHONE"



DB-49D



DB-50



DB-50A



DB-60



MIS-T-100



MIS-TH-100



MIS-TH-100-P



S.H.E. IS A 10

1. Machine RoomLess Elevator
2. Smooth ride counter-weighted traction equipment
3. No hydraulic oil
4. VVVF Drive
5. Standard LED lighting
6. Car Operating Panel with Emergency Light and Phone
7. Real Wood cab
8. 950 lb. capacity
9. 40 feet per minute
10. Made in the USA

CALL US : 800-526-0026



CUSTOMIZE

Choose from a wide range of features and options including wood types, handrails, light fixtures and cab styles. SEES will work with you to bring your vision to life.



MACHINE ROOM-LESS

No hydraulic cylinder, machine room or hydraulic oil. Instead, S.H.E. uses a small electric motor which fits within the hoistway overhead.



ENERGERY SAVINGS

Thanks to the efficient motor and traction equipment, S.H.E. energy savings are estimated at 70-80% compared to hydraulic elevators.

WHY A SEES HOME ELEVATOR?

All SEES Home Elevators come with the SEEScreen Electronic Door Detector, designed to ensure maximum passenger safety. The SEEScreen's 94 infrared beams act as an invisible safety curtain across the door entrance. When an obstacle breaks the screen, the sensors detect it and immediately stop the elevator to avoid any accidents.



CONVENIENCE

S.H.E. improves in-home mobility and gives you the freedom to safely access any floor with ease.



INVESTMENT

S.H.E. is a sound investment and will increase your home's value and expand its marketability.

CONTACT US

By Phone:
800.526.0026
954.971.1115

By Fax:
954.917.7337
Visit Us: www.SEEInc.com



FLEXIBILITY

Purchase the S.H.E. with or without the cab. SEES will work with you to design and build exactly what you want.



MADE IN THE U.S.A.

S.H.E. is constructed from the finest materials at the SEES Modernization Center in Fort Lauderdale.



Car Signal Components

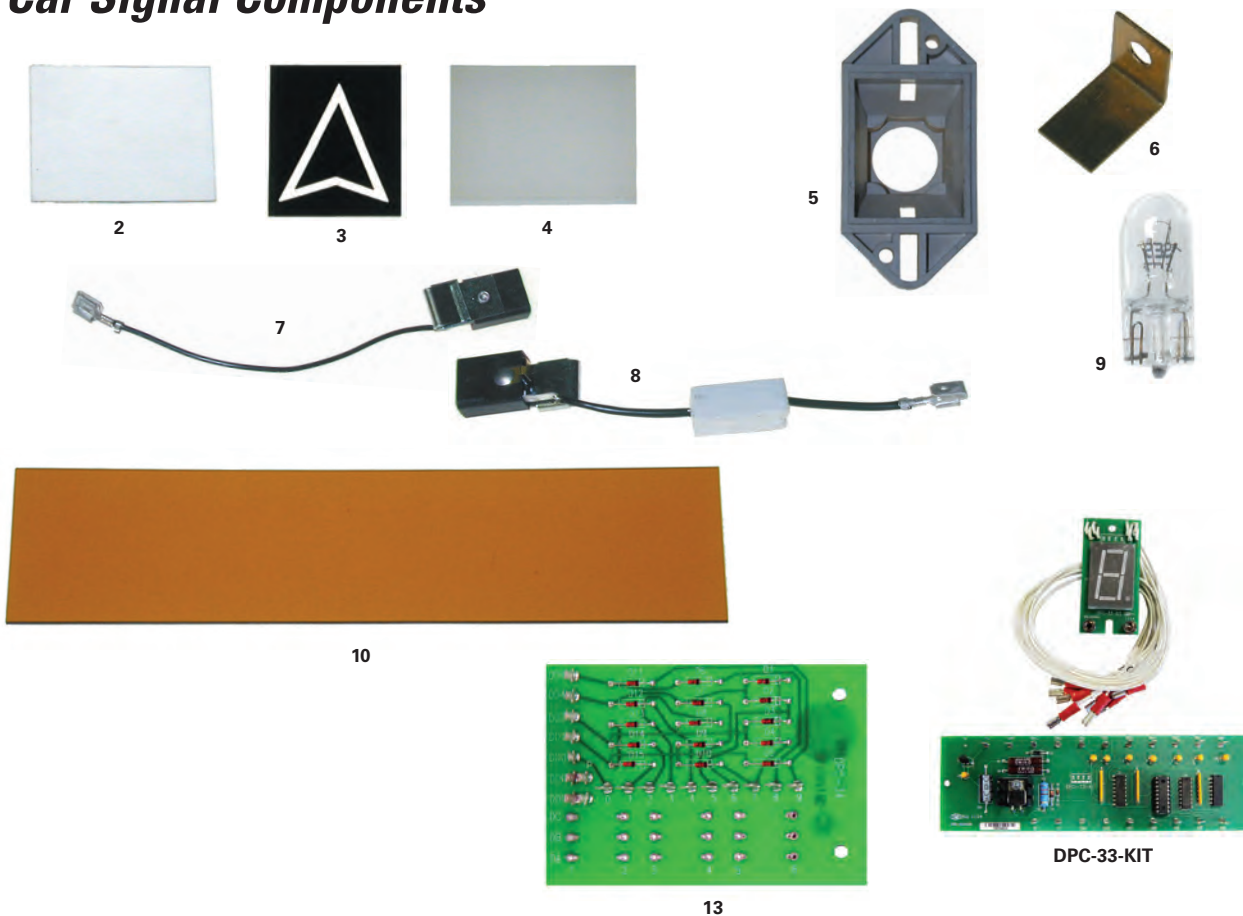

DOVER

Digital Position Indicator

Item	S.E.E.S. #	O.E.M. #	Description
2	DB-62	9714212, 114205	Reflector lens, 1.03" x 1.28", for digital position indicator
3	DB-67-	114212	Discrete film, 1-1/4" x 1", specify marking, i.e. DB-67-ARROW
4	DB-63	9714200, 114204	Reflector diffuser for digital position indicator
5	DB-64	114202, 9753746	Reflector for lamp for digital position indicator
6	DB-65	107184	Clip for digital position indicator assembly
7	DB-52D	9727164, 107186	Lamp holder assembly, for 24V position indicator assembly
8	DB-52C	9778174, 112639, 9712630	Lamp holder assembly, with resistor, for 48V position indicator
9	ML-57	9727190, 107189	Lamp, #657, 28V wedge base
	DB-67-6		Discrete Film, "6" for digital position indicator
10	DB-68	9844284, 114284	Amber lens, 6-1/2" x 1-9/16", for digital position indicator
	DB-56	9880239	Lens, 5-1/2" x 1-9/16", red, for digital position indicator
	DB-68A	9830595	Red lens, 6-1/2" x 1-9/16", for digital position indicator
	DPC-32B		P.C. Board, LED Driver Board Replaces Old DPC-32
	DPC-33-KIT		PCB & PI Led Display, DPC-32B, DPC-33A
	DPC-33A		P.C. Board, PI LED Display Replaces DPC-33 / Plasma
13	DPC-34	1133323, 9813378, 9813366	P.C. Board, decoder printed circuit board assembly 0-9, L & P
	DPC-18A	9830595	P.C. Board, PI interface

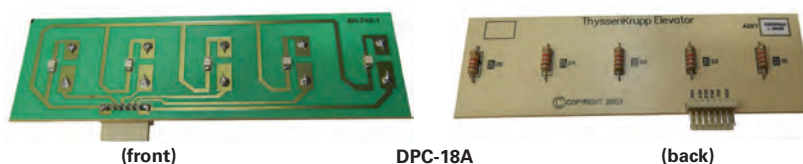

Car Signal Components



Gongs and Buzzers

S.E.E.S. #	O.E.M. #	Description
DB-71	9871937, 107193	Gong assembly, 24 VDC, brass single stroke gong with mounting bracket
DB-71A	9737194, 107191, 9711818	Gong, 24 VDC, brass single stroke gong alone
DB-72	9871925, 107924	Gong assembly, 48 VDC, brass single stroke gong with mounting bracket
DB-72A	9751580, 9711820, 9737170	Gong, 48 VDC, brass single stroke gong alone
DB-72B	9724394, 32429	Gong, 120 VAC, single stroke gong
DB-72C	9882765	Buzzer, 24-130 VDC
DB-72D	9882753	Buzzer, 24-48 VDC
DB-72E	9726603	Buzzer, 120 VAC
CYB-382-S	9830169	Handicap tone alarm, 10-48 VDC
DB-72K		Handicap tone alarm, 3-28 VDC, 85d.b. 3.5kh range
DB-200	9727413	Gong Assembly, Single Stroke, Lantern, Includes brackets, brass
DB-201	9882777	Buzzer, 24V, Fire Service, TAC

Belts

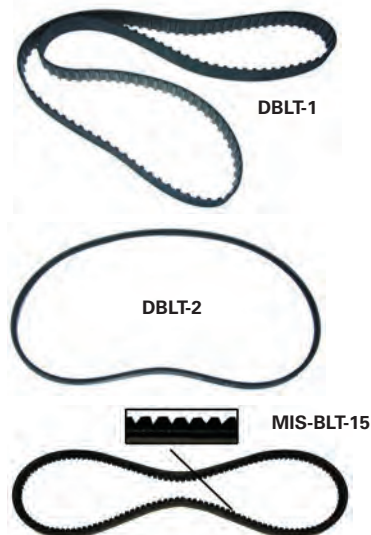

S.E.E.S. #	O.E.M. #	Description
DBLT-1	9749524, 77021	Timing belt, 48" x 1", 128 teeth, 48 arc, 3/8 pitch

S.E.E.S. #	O.E.M. #	Belt #	"V" Belt Dimensions
DBLT-2	9749512, 77018	1410, 3L410	41" x 3/8"
DBLT-3	9749152	1420, 3L420	42" x 3/8"
DBLT-7		1500	50" x 3/8"
DBLT-5		2500	50" x 1/2"
MIS-BLT9	9729756, 701975	3VX400	40" x 3/8"
MIS-BLT10	9729756	3VX425	42.5" x 3/8"
MIS-BLT11	9735252, 103515	3VX450	45" x 3/8"
MIS-BLT12	9749548	3VX475	47.5" x 3/8"
MIS-BLT13	9749433, 9772777	3VX500	50" x 3/8"
MIS-BLT14	9749550	3VX530	53" x 3/8"
MIS-BLT15	9749494, 77918	3VX560	56" x 3/8"
MIS-BLT16	9749408, 77919	3VX600	60" x 3/8"
MIS-BLT17	9749470, 77920	3VX630	63" x 3/8"
MIS-BLT17A	9749470	3V630	63" x 3/8"
MIS-BLT18	9749410, 77921	3VX670	67" x 3/8"

Brushes and Brush Holders



DBH-1



DBH-1A



DBH-2

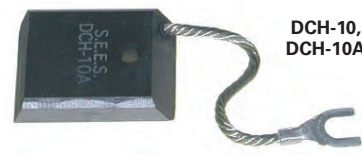

DCH-10,
DCH-10A



DCH-11A,
DCH-16



DCH-17, DCH-18



DCH-19



DCH-11



DCH-14



DCH-20



DCH-1



DCB-200



DCH-2



DCH-3



DCH-4

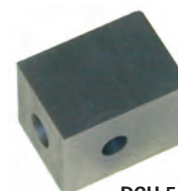

DCH-5

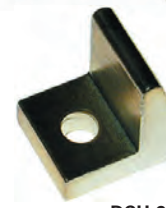

DCH-9

S.E.E.S. #	O.E.M. #	Description
DBH-1	9715307, 9745129	Brush holder for brushes DCH-10 and DCH-10A, .940 hole
DBH-1A	9745142	Spring clip for holder DBH-1
DBH-2	9717341	Brush Holder , for DCH-11A brush
DCH-10	9713888, 21388	Carbon brush , 1/2" x 1-1/2" x 2", bevel; shunt end 30 degrees, bottom 15 degrees
DCH-10A	9711533, 115316	Graphite brush , 1/2" x 1-1/2" x 2", bevel; shunt end 30 degrees, bottom 15 degrees
DCH-11A	9776898	Carbon brush , 5/16" x 1-1/4" x 2", top unbeveled, bottom bevel 15 degrees
DCH-12		Shunt , 12 3/4" Long
DCH-16	9711752	Carbon brush , 5/16" x 1-1/4" x 2", top bevel 30 degrees, bottom bevel 20 degrees, shunt 3-1/2"
DCH-17		Carbon brush , 3/8" x 1/4" x 7/8" replacement brush for SEES DDO-31 motor
DCH-18		Carbon brush , 5/16" x 5/8" x 1" replacement brush for SEES DDO-31E motor and Magnetek
DCH-19		Motor Brush , for 9801704 (DDO-31E Current Model), .375" W x .260" Th x .650" L
DCH-19A		Motor Brush , For 9801704, Set of 2.375" W x .260" Th x .650" L
DCH-20	9819447	Brush , 1/2" x 1-1/2" x 2"
DCH-11	9743601	Carbon brush , 3/8" x 1-1/4" x 2", bevel; shunt end 30 degrees, bottom 15 degrees
DCH-13	9743674	Carbon brush , 3/8" x 1" x 2", bevel; shunt end 30 degrees, bottom 15 degrees
DCH-14		Motor brush , 1/4" x 3/8" x 1", bevel; shunt end 15 degrees, bottom unbeveled
DCB-200	9710565	Brush , Door Motor Reliance Model M

Carbon Holders and Contacts

S.E.E.S. #	O.E.M. #	Description
DCH-1	9828229	Carbon holder , stem 4-3/4" L with 1/4 - 20 thread, overall 6" L
DCH-2	9770719	Carbon contact , 1/2" diameter x 3/4" L
DCH-3	9792910	Copper contact , 1/2" diameter x 3/4" L, silver face
DCH-4	9828175, 62817	Carbon holder , stem 5" L with 5/16- 24 thread, overall 6" L
DCH-5	9770800	Carbon contact , 1" x 1" x 1-3/8"
DCH-6	9828084, 62808	Carbon holder , stem 6" L with 3/8" - 16 thread, overall 7-1/2" L
DCH-7	9771189	Carbon contact , 1-1/2" x 1-1/2" x 1-1/2"
DCH-15	9740867	Carbon contact , 1-3/16" x 1" x 1-1/8"
DCH-9	9820565	Copper contact , silver plated with 1" x 1-1/4" face

Contacts



DC-1



DC-3



DC-4



DC-5



DC-6



DC-7



DC-2



DC-1A

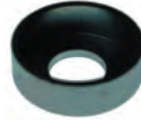

DC-1C



DC-1S

S.E.E.S. #	O.E.M. #	Description
DC-1	9828205	Contact , shank 1/2" x 2-1/4" with 1/2" diameter copper tip
DC-1A	26992	Post , spring, with Cotter Pin
DC-1C	26993, 9769936	Cup , washer for post DC-1A
DC-1S	26994, 9769948	Spring , contact for post DC-1A
DC-2	9792909	Contact , shank 1/2" x 2-1/4" with 1/2" diameter silver tip
DC-3	9820589	Copper contact , 2-3/8" L x 5/8" W, with 9/32" diameter hole
DC-4	9820607	Copper contact , 2-3/8" L x 5/8" W, with 3/8" silver tip
DC-5	9810840	Copper contact , 1-15/16" L x 1/2" W, with 7/32" diameter hole
DC-6	9821284	Copper contact , 1-15/16" L x 1/2" W, with 3/8" diameter silver tip
DC-7	9828096, 1352	Contact with shank, 3/4" x 4-1/4", with 1-1/2" x 1-1/2" x 5/16" copper face. For 9771189 stationary contact
DC-8	9828217, 1350	Contact with shank, 5/8" x 3-1/4", with 1" x 1" x 1/4" copper face. For 9770800 and 9820565 stationary contact



DC-9

Threaded contact studs

S.E.E.S. #	O.E.M. #	Description
DC-9	9821302	Contact stud , threaded brass, 3/8" diameter silver tip, 3-7/8" L
DC-10	9821727, 60922	Contact stud , threaded brass, 1/4" diameter silver tip, 2-3/16" L
DC-11	9821739, 60923	Contact stud , threaded brass, 1/4" diameter silver tip, 2-15/16" L
DC-12	9821405	Contact stud , threaded brass, 1/4" diameter silver tip, 3-11/16" L



DC-13



DC-14

Contacts for 66089 Limit Switch

S.E.E.S. #	O.E.M. #	Description
DC-13	9861336, 66133	Stationary contact with silver tip
DC-14	9761585, 66158	Movable contact with silver tip

Contacts



CKF-1



CKF-3



CKF-5



CKF-8



CKF-10



CKF-11



CKF-12



CKF-13



CKF-14



CKF-16



CKF-15

Contact Kits

S.E.E.S. #	Contact #	Contact Kit #	Description
CKF-1	9755330, 75533	9788785, 9755536 75553, 9790111	Size 2 Contact Kit , Furnas 75FB14A for "old style" vertical 75563 contactor
CKF-2	9755548, 75554	9755810, 35581	Size 2-1/2 Contact Kit , Furnas 75GB14 for vertical contactor
CKF-3	9755354, 75535, 75555, 75565	9755822, 35582, 9790238	Size 3 Contact Kit , Furnas 75HB14 for vertical contactor
CKF-4	9755366, 75536, 75556, 75566	9755834, 35583, 9790263	Size 3-1/2 Contact Kit , Furnas 75IB14 for Model B "old style" vertical contactor
CKF-5	9755378, 75537, 75557, 75567	9755834, 35583, 9790287	Size 4 Contact Kit , Furnas 75JB14 for Model B "old style" vertical contactor
CKF-8	9755317, 75531	9755792, 9790081, 35579, 75551, 75561	Size 1 Contact Kit , Furnas 75DF14 for "old style" vertical contactor
CKF-10	112194	9788748, 9790135	Size 2 Contact Kit , Furnas 75FF14 for 45 degree green contactor
CKF-11	9754714, 9713384	9790160	Size 2 Contact Kit , Furnas 75FP14 for 45 degree grey contactor
CKF-11A		75FP14	Size 2 Contact Kit , Furnas Size 2 #75FP14, Silver Contact
CKF-12	9755640, 75564	9790196	Size 2-1/2 Contact Kit , Furnas 75GF14 for 45 degree contactor
CKF-13	9755342, 75534	9790226	Size 2-1/2 Contact Kit , Furnas 75GP14 for 45 degree contactor
CKF-14	9755433, 9713396, 9818194	9790240	Size 3 Contact Kit , Furnas 75HF14. Starter goes in on a 45 degree angle
CKF-16	9790251	9790251	Size 3 (75A) Contact Kit , Furnas 75HF15 for vertical contactor
CKF-15	9755445	9790275	Size 3-1/2 Contact Kit , Furnas 75IF14 for Model B "old style" vertical contactor

Contacts



DCK-2

DCK-3



DC-15



DC-16



DC-17



DC-18



DC-20



DRP-20



DRP-20I



DCM-001

Contact Kits

S.E.E.S. #	Contact #	Description
DCK-1	9955045	Auxiliary Contact, Furnas 49D54682N0
DCK-2	9790317	1 Pole Contact Kit, Furnas 75NB41
DCK-3	9790123	1 Pole Contact Kit, Furnas 75FE42

Contacts for DC Contactors "14 and 15" Switches

S.E.E.S. #	O.E.M. #	Description
DC-15	9759001	Stationary contact, normally closed
DC-16	9758902	Movable contact
DC-17	9759098	Stationary contact, normally open
DC-18	9758872	Spring, contactor, 8 turns
DC-19	9758884	Spring, contactor, 6 turns
DC-20		Spring, contactor, 6 turns, conical
DRP-20	9871184, 77118	Contact, 48 VDC coil, Single pole, double throw, make before break contacts, for #15 Switch
DRP-20A	9871196, 77117	Contact, 48 VDC coil, Single pole, double break contacts, for #14 Switch
DRP-20I	10074	Cradle block, contact guide for movable contact
DCM-001	9723596	Mount, Contactor Isolation 8-34" x 3/8" Long 2 Studs

Capacitors



DCAP-1



DCAP-2



DCAP-11



DCAP-7



DCAP-4



DCAP-9



DCAP-200



DCAP-201

S.E.E.S. #	O.E.M. #	Description
DCAP-1	9778044	Capacitor, 780 MFD, 250 VDC
DCAP-2	9779334, 77933	Capacitor, 4600 MFD, 25 VDC
DCAP-3		Capacitor, 270-324 MFD, 125 VAC
DCAP-4	9886667	Capacitor, 1 MFD, 600 VDC
DCAP-5	9768439	Capacitor, 2700 MFD, 40 VDC
DCAP-6	9764185, 76418	Capacitor, 1500 MFD, 50 VDC
DCAP-7	9763302, 76330	Capacitor, 500 MFD, 150 VDC
DCAP-8	9757600, 75760	Capacitor, 525 MFD, 300 VDC
DCAP-9	9755196	Capacitor, 2000 MFD, 450 VDC
DCAP-10	9713888	Capacitor, Dover, 440 VAC, 60mf, used On Tac-20 / 3 Per Motor
DCAP-11	9716865	Capacitor, 2800 MFD, 450 VDC
DCAP-12	9741379	Capacitor, Electrolytic 1300mf 50V CGS, Screw Caps
DCAP-200	238AD1	Capacitor, 90 MFD, 500 VDC/240 VAC
DCAP-201	9856250	Capacitor, 250 MFD, 50V with T Pins
DCAP-202		Capacitor, 100 MFD, 50V with T Pins

Coils



DCO-1



DCO-3A



DCO-4



DCO-5



DCO-5B



DCO-7

DC Contactor Coils 230V

S.E.E.S. #	O.E.M. #	Description	I.D.	O.D.	Length
DCO-1	9770124, 27012	1932 Ohm average	1-1/4"	2-3/4"	3"
DCO-2	9769870, 26987	462 Ohm average	1-5/16"	2-3/4"	2-7/8"

Starter Coils

S.E.E.S. #	O.E.M. #	Description
DCO-3A	9755469	Dual voltage coil, 110V/220V for starter sizes 3 - 3-1/2
DCO-3B	9788761	Dual voltage coil, 110V/220V for starter sizes 0 - 2-1/2

Coil 48VDC used on #14 and #15 switches

S.E.E.S. #	O.E.M. #	I.D.	O.D.	Length
DCO-4	9758940	1"	2"	2"

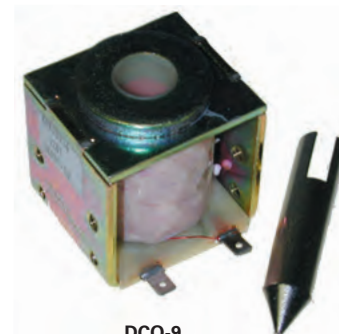

DCO-9

I-2 Valve Coils

S.E.E.S. #	O.E.M. #	Voltage	I.D.	O.D.	Length
DCO-5	9722300	120 VAC	1/2"	1-1/4"	1-1/4"
DCO-5B	9731659	220/230 VAC		1-1/2"	1-1/2"

Brake Coils

S.E.E.S. #	O.E.M. #	Description
DCO-7	9742440, 26326	Brake coil, 220 VDC, 395 Ohm, 3" I.D., 5.5" O.D., 5.45" L
DCO-8	9742463, 26327	Brake coil, 140 VDC, 170 Ohm
DCO-10	9742463, 26327	Inductor coil, with spade lugs

Solenoid Coil for Selector

S.E.E.S. #	O.E.M. #	Description
DCO-9	9869918, 76991	Solenoid coil, 24 VDC, for selector, coil .510" I.D., plunger .5" dia



DCO-10

Door Parts and Equipment

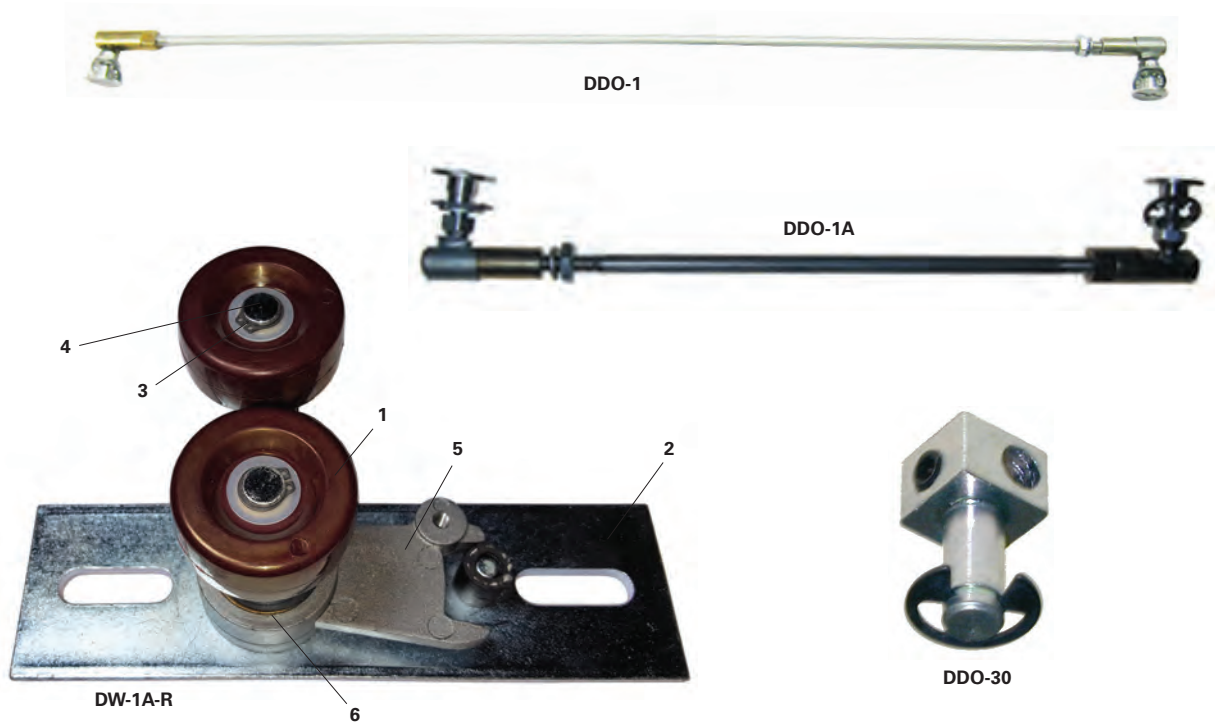

Rod Assembly

S.E.E.S. #	O.E.M. #	Description
DDO-1	9828667 9866760	Ball joint and rod link kit for interlock hook and Dover series door clutch roller assemblies, rod 18" L
DDO-1A	129995	Ball joint and rod link kit for restrictor clutch, rod 8" L
DDO-30	9747035	Rod Attachment

Door Pick-up Roller Assembly

Item	S.E.E.S. #	O.E.M. #	Description
1-6	DW-1A	9875256, 47526	Pick-up roller assembly, with steel mounting base. Assembled L.H. (interchangeable L.H. or R.H.)
	DW-1A-R	9875268, 47525	Pick-up roller assembly, as above. Assembled R.H. (interchangeable R.H. or L.H.)
1	DW-1-P	D-803R1-POLY	Roller kit, 1-5/8" O.D. Poly Blue with Bushing and ring
	DW-1-PS	D-803R1-POLY-SOFT	Roller kit, 1-5/8" O.D. Poly Black - Soft with Bushing and ring
2	DW-1B	9897641, 29764	Steel base for DW-1A assembly
3	DW-1C	9736141, 70115	Retaining ring for DW-1
4	DW-1D	9801157, 40115	Shaft for DW-1 roller
5	DW-1E	9838181, 47529	Roller crank
6	DW-1F	9759268, 75926	Ring Tru-Arc, 1" shaft
	DW-1G	D-803R1, 9721058	Roller Kit, Replacement for Ja IVO / 3S (3 wheels & Hdw)
	DW-1G-1		Shaft, for DW-1G
	DW-1-HDW		Hardware Kit for DW-1, Retaining Ring and Washer, Bag of 10
	DW-1S		Pickup Roller, with Shaft and Retaining Ring
	DDO-205R		Interlock Conversion Kit, R.H.
	DDO-205L		Interlock Conversion Kit, L.H.
	DDO-206R		PU Roller, Conversion Kit, R.H. - US
	DDO-206L		PU Roller, Conversion Kit, L.H. - US



DW-1-P

S.E.E.S. #	O.E.M. #	Description
DDO-3	9838521, 9892916	Door contact base block assembly , steel spring contact blades and silver contacts on a heavy duty insulator, used on DDO-3B, DDO-3C, DHE-3 and DHE-5
DDO-4	9751221	Contact , movable contact assembly
DDO-3B	9865056, 66505	Interlock assembly , R.H.
DDO-3C	9865044, 66504	Interlock assembly , L.H.
DDO-3E	9838466	Cover , only, for interlock
DDO-3E-A	9838466	Cover , only, for interlock, with UL Label
DDO-3F	9863021	Interlock , 297BJ2
DDO-5	9866760, 9838776, 9838375, 9801042, 9875219	Interlock latch assembly
DDO-6	9866760	Nose contact bridge included in DDO-5 assembly
DDO-6C	9801042	Contact , only, for DDO-6 contact bridge
DDO-32	9701230	Cam , slow down switch cam
DDO-33	9701692	Cam , stop/limit switch cam
DDO-33A	44127	Cam shaft , for DC-68 door operator, 5-1/4" L

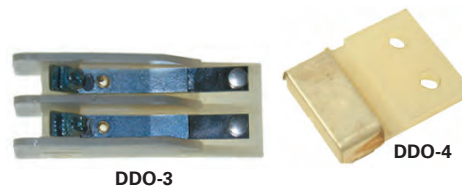

S.E.E.S. #	O.E.M. #	Description
DDO-5A	9801352	Mounting bolt , 1-15/16" O.L., 3/8-24 thread for interlock latch assy. DDO-5
DDO-5B	9801224, 9801479	Mounting bolt , 1-1/4" O.L., 3/8-24 thread for interlock latch assy. DDO-5
DDO-7	9701011, 9758525	Bushing set , 4 piece, nylon, includes DDO-7A and DDO-7B
DDO-7A	9701011	Nylon bushing , 1/2" per print
DDO-7B	9758525	Nylon bushing , 1/4" per print

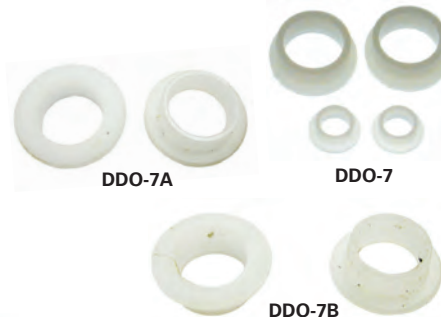

S.E.E.S. #	O.E.M. #	Description
DDO-8	9850909, 45090	Contact , gate switch, for Dover door operator, clear acrylic plastic with silver plated brass contact for gate switch contact
DDO-9	9772637, 77263	Gate switch contact for DC-68 Door Operator, makes with 9850909

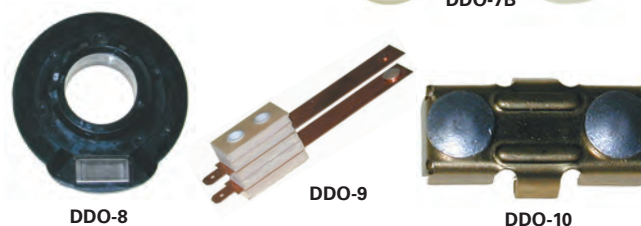

Interlock 66000 & 66001 Components

S.E.E.S. #	O.E.M. #	Description
DDO-10	9761263, 66126	Interlock latch contact , movable, brass base with two 3/8" diameter silver contacts
DDO-10A	9780373, 28037	Insulator for DDO-10
DDO-10/10A-1		Base & Contact to make DDO-10 & 10A
DDO-11	9761457, 66145	Contact for interlock switch , stationary, two needed for DDO-10





DO IT RIGHT THE FIRST TIME

"THE REQUIREMENTS FOR DOOR RESTRICTORS WAS IMPLEMENTED TO PREVENT PASSENGERS FROM FALLING INTO AN OPEN HOISTWAY UNDERNEATH THE ELEVATOR PLATFORM WHILE TRYING TO EVACUATE FROM AN ELEVATOR THAT IS STUCK BETWEEN FLOORS."

~AMERICAN SOCIETY OF MECHANICAL ENGINEERS

ELECTRICAL vs. MECHANICAL

Requires electric power & battery back up at all times.	vs.	Works even when power is out.
Coils burn up from continuous use.	vs.	Plastic edging protects wires & cables.
Functionality affected by severe temperatures (hot or cold).	vs.	Works in all types of weather conditions.
Required maintenance on plunger, battery, or PC Boards.	vs.	Maintenance Free!
Many false entrapments & call backs.	vs.	No Call Backs!
High Product Costs.	vs.	Lowest cost solution.

SEES RESTRICTOR: THE PREFERRED MECHANICAL DOOR RESTRICTOR



PART# SEES-RESTRICTOR-003
(FLAG SMALL ADJUSTABLE 1.25"-2")

PART# SEES-RESTRICTOR-004
(FLAG LARGE ADJUSTABLE 2"-2.875")



PART# SEES-RESTRICTOR-005
(SHIM KIT w/ HARDWARE)



PART# SEES-RESTRICTOR-006
(FLAG FIXED 1" LENGTH)



PART# SEES-RESTRICTOR-007
(FLAG FIXED 3" LENGTH)

Always Smooth Sailing



Door Parts and Equipment

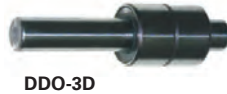
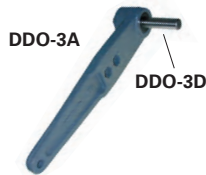

DC-68 Mark II Components

S.E.E.S. #	O.E.M. #	Description
DDO-3A	9838820, 40006	Idler arm with bearing
DDO-3D	9759372, 85107	Bearing for DDO-3A
DDO-17	9791577, 69157	Switch assembly for DC-68 Operators
DDO-18	9876686, 67668	Sheave, 12" for jack shaft, mounts on DDO-3A Arm assembly, replaces old style 13" sheave, for DC-73 & DC-85 Operator
DDO-18A	9843954, 44395, 9820966, 9811667	Motor pulley
DDO-18B	9842214	Drive Sheave, 14" for DC 68 Operator, for DC 68 & 91 Operator



Gibs

S.E.E.S. #	O.E.M. #	Description
DDO-13F	9807871	Shoe Liner
DDO-13G	9808383	Guide Shoe, 30# Rail, without liner
DDO-15	9881980, 11819	Door guide kits, door gib assembly (replaces 118192)
DDO-15A	9782114, 118190, 76345, 9818170	Gib insert for DDO-15, gib width 1/2"
DDO-15-SS		Door Gib Assembly, Stainless Steel with S/S hardware
DDO-34	9885273, 559AB1, 9897951	Gib, insert Omega, guide liner 7/8" x 6"
DDO-34B	9897940, 9897938	Omega Guide Shoe Assembly, upper & lower, 454AC3/454AC4
DDO-34C	196CE2	Mounting Bracket, for Omega Guide Shoe Assembly #256AX1 for 2"
DDO-34D		Pivot Shaft, for Omega Guide Shoe
DDO-41	9885237	Gib, Freight gate guide shoe gib, metal
DDO-41A	9811400	Liner, Freight gate shoe liner phenolic
EPCO-GIB-T T		Door Gib, Adjustable 1/2" W blue nylon
DDO-203	9875220	Hook Assembly, for Low Pocket Interlock Right Hand
DDO-204		Door Gib, Guide Assembly Heavy Duty Plow Replacement
DDO-204A		Door Gib, Guide Assembly with Shaft Heavy Duty Plow Replacement
DDO-204B		Shaft, Only for DDO-204 and DDO-204A Heavy Duty Plow Replacement
DDO-204C		Door Gib, Bracket & Guide Assembly with Shaft Heavy Duty Plow Replacement
DDO-207	9710398	Stiffener Angle
DDO-208		Retainer Linear (EA51-11)
DDO-209		Shim Retainer
DDO-210		Retainer, Saftey Door



DDO-13F



DDO-15

DDO-15A



DDO-34



DDO-15-SS



DDO-34B



DDO-34C



DDO-204



DDO-204B



DDO-204A



DDO-41



DDO-41A

Door Parts and Equipment

DOVER



DDO-25



DDO-25A



DDO-25B



DDO-25C



DW-12



DW-12A



DW-12B

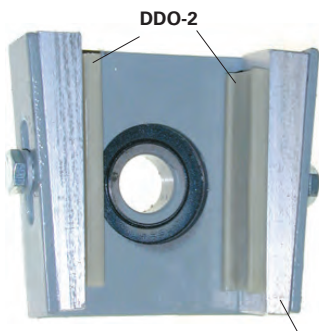

DDO-21

DDO-21B

■ DW-12 Spacer and DW-12B Bolt used for DDO-21, DDO-21A, DDO-25 and DDO-25A



DDO-13



DDO-13A



DDO-13B



DDO-13C



DDO-13D



DDO-37



DGS-200

S.E.E.S. #	O.E.M. #	Description
DDO-25	9723997, 9811667, 123992	Arm , adjustable 8-1/2" L x 2" W x 1/2" Thick
DDO-25A	9723985, 9801947, 103260, 123990	Arm and bearing assembly , for slide assembly 5" L x 2" W x 1/2" Thick
DDO-25B	98384541, 108678	Connecting Arm , 12" DC 68 2 with bearing
DDO-25C	9838831	Link , Connecting 7.5" Print 111195
DDO-21	9838697, 63869	Slide Assembly complete
DW-12	9801236, 40121	Spacer , arm bearing, used with DDO-21, 21A, 25, 25A
DW-12A	9801170, 40117	Spacer for door hanger, used with DDO-21, 21A, 25, 25A
DW-12B	9700742	Screw socket , 3/8-16 x 1-1/4"
DDO-21A		Bracket and bearing for slide assy DDO-21
DDO-21B	9806623	Slide holder for DDO-21 assembly
DDO-2	9838685	Slide insert for DDO-21 assembly 2-1/2" L x 3/4" W
DDO-13	9805266, 10526	Ivo slide guide shoe , 5-1/2" x 1", 3-1/2" c/c mtg., used with DDO-13C Holder
DDO-13A	9808267, 40826	Base , guide shoe
DDO-13B	40828	Shaft with nut , guide shoe
DDO-13C	9808279, 40827	Holder , guide shoe, 5-1/2" x 2.15", includes DDO-13 guide shoe installed
DDO-13D	9808292	Cushion
DDO-13E	9753485	Bumper , Door, Rubber 3/4" diameter
DDO-37	9814656, 114653	Door stop bracket
DRP-32B	298AG2	Interlock , Mechanical, for Dover
DGS-200	9769286	Insert , Guide Shoe Liner, IVO
DHDW-001	131AKI, 9898653	Spacer , Rubber 1.125 O.D.

Door Parts and Equipment

S.E.E.S. #	O.E.M. #	Description
DDO-18A	9820966, 9811667 9843954, 44395	Motor pulley , 2" O.D., 1-1/2" O.D. for two V-belts, I.D. for 1/2" shaft, used with DDO-31 for HD-73 Operator
DDO-31	9746602	Door Motor , permanent magnet door motor 1/6 HP 230 VDC, 1140 RPM, shaft 1/2", uses DCH-17 brush. 8 amps & 48 frame
DDO-31A	9711739, 101172	Rear bearing assembly , includes DDO-31C strap
DDO-31C		Strap upper and lower for rear bearing assy
DDO-31D	9711715, 101171	Main bearing assembly
DDO-31E	9801704, 141707	Door motor , 1/6 HP, 1340 RPM, 115 VDC, uses DCH-18 brush, shaft 1/2"
DDO-31EA	9872070	Door motor , 1/6 HP 1145 RPM, 230 VDC PM
DDO-31F	9741770	Pulse Tach , assembly for DDO-31E
DDO-31F-A	141771	Interrupter , photo sensor
DDO-31F-B	228AE2	Interrupter Wheel
DDO-31F-C	OJ3703/OS3701	Harness Assembly
DDO-31F-D		Magnetic Switch , 2 wire used on Tach, hamlin
DDO-31F-E	711AB2	Housing , for Pulse Tach
DDO-31G	9877228	Encoder for Tach 20/50 1024cpr, for governor
DDO-31H	9861982	Door Motor Encoder , for Smart Tech HD9, includes mounting plate & hardware
DDO-31I	9815740, 6300FA1	Encoder , for governor
DDO-31M	9723420	Motor mount , rubber shock absorber
DDO-46	9779504	Motor , Door with Encoder, 1/6HP, 115 VDC, 1.4 amp, RPM 1150, Class F type 1350
DDO-46A	9825431	Encoder , For door motor DDO-46
DDO-47	9841775	Motor , with sensor, 1/6HP, 115 VDC, 1.4 amp, RPM 1150, Class F type 1350
DS-54	9807536	Transducer , Terminal, NTSD/ETSD
DS-55	9780853	Transducer Assembly , Position
TDO-01	9817920	Door motor , R/H 120 VDC 1/6HP encoder & drive pulley assembly



DDO-18A

DDO-31

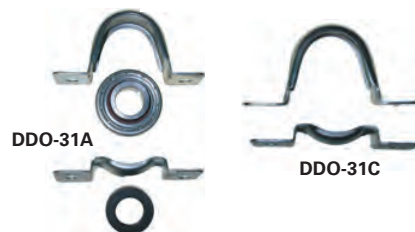

DDO-31A

DDO-31C



DDO-31E



DDO-46



DDO-31F-C

DDO-31F-B

DDO-31F-D

DDO-31F
(Replaces all prior models)



DDO-31EA



DDO-31M



DDO-31G



DDO-31H



DDO-46A

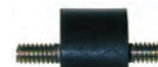

DDO-31M



DDO-46



DDO-31G



DDO-47

Door Parts and Equipment

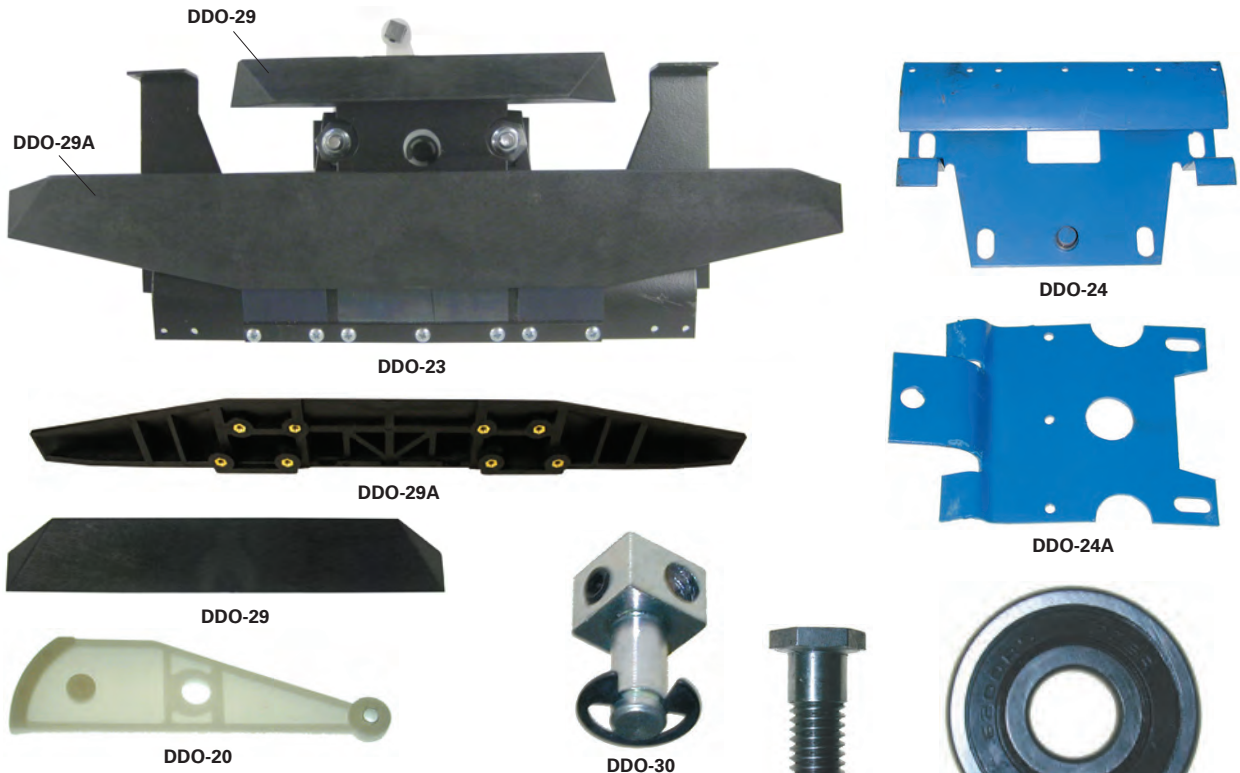

Door Clutch and Components

S.E.E.S. #	O.E.M. #	Description
DDO-22	9863862, 63856, 9951568, 127235	Clutch assembly, L.H.
DDO-23	9863898, 63891, 9951570, 127236	Clutch assembly, R.H.
DDO-29	9801443, 9811667	Closing clutch vane 9"
DDO-29A	9800955, 40099	Opening clutch vane 20"
DDO-24	9838703	Clutch base, R.H. or L.H.
DDO-24A	9800141, 40014	Closing vane support
DDO-24B	9819642, 41964	Bolt used with DDO-24C
DDO-24C	9870076, 77007	Bearing used with DDO-20 actuating cam
DDO-24D	392CH1	FS, Screw, CSH Shoulder, CE 2.25" OA Length Shank
DDO-24E	392CH2	FS, Screw, CSH Shoulder, CE 1.875" OA Length Shank
DDO-20	9800888	Cam, clutch actuating cam
DDO-30	9747035	Rod attachment
DSE-1L	9822276	Link Rod
DDO-12	9801066	Spring vane, flat, 2-1/2" H x 2" W
DDO-14	9838806	Spring vane, flat, 4" x 4"
S.E.E.S. #	O.E.M. #	Description
DW-13	9780158 9701588	Sheave, 2.4" O.D. x .3937" I.D. for 40158 DW-13B assembly
DW-13A	9838594	Bracket for DW-13B assembly
DW-13B	9838594 9950965	Relating cable assembly, includes DW-13 and DW-13A

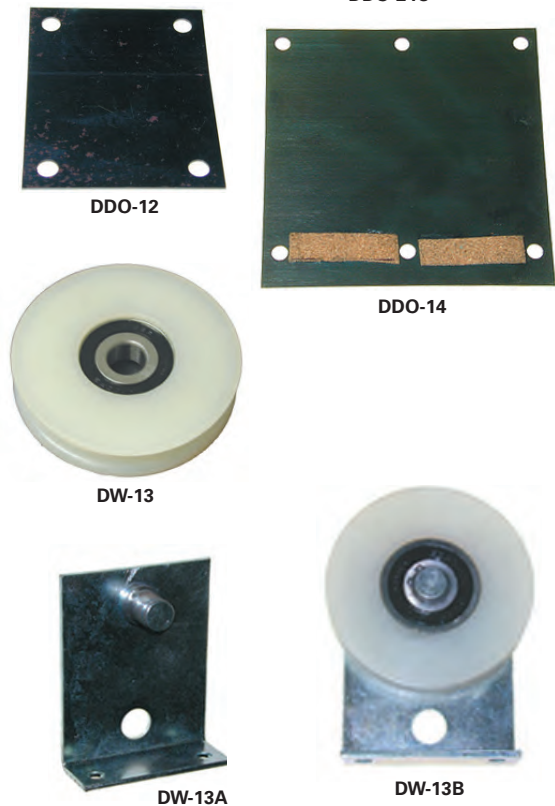

Door Parts and Equipment

S.E.E.S. #	O.E.M. #	Description
DDO-40	9954090	Door restrictor assembly, 5ft length
DDO-40A	147721	Spring for DDO-40 Door restrictor
DDO-40B	9954144	Angle Bracket, set, angle for restrictor
DDO-40C	9954132	Header Bracket for restrictor
DDO-40D	9779486	Restrictor Angle Assembly, 72" for 8ft Pivoting Door
DDO-40E	9779498	Restrictor Angle Assembly, 9ft Pivoting Door
DDO-40BC-KIT	9743297	Hoistway Restrictor Kit, includes one each DDO-40B & DDO-40C
DDO-42	860AE14	Car Door Hanger Rail, 98" Dover, "J" (no holes)
DDO-43	9782266	Old Style Central Cable, for LDO-3 door operator
DDO-45	9836408	LDO-3 Operator Magnet & Sensor kit, N.O.
DDO-200	9710190	Bumper, for Door Recess Mounting
DDO-201	118194	Retainer, Fire Tab Z Bracket
DDO-202	9848071	Door Guide, Gib Assembly
DDO-203	9875220	Hook Assembly, for Low Pocket Interlock Right Hand

Center opening doors need two each DDO-40B for intermediate floors, one each for top and bottom (terminal) floors. Single opening doors need one each DDO-40B and DDO-40C per floor, per car.



DDO-40



DDO-40A



DDO-40B



DDO-40C

For more door restrictor options, see SEES Restrictors on page 261.

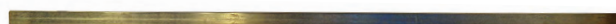

DDO-42
Close up



DDO-200



DDO-40BC-KIT



DDO-45



DDO-201



DDO-202

DMC Operator Components

S.E.E.S. #	O.E.M. #	Description
DDO-35	9741227, 141222	Door cam limit for HD-85
DDO-36	9741252, 141251	Magnet for DDO-35
DDO-36A	9741653, 141555	Reed switch assembly for DMC Car Top
DCB-200	9710565	Brush, Door Motor Reliance Model M
DMC-001C	9850922	Cable, for DMC Laptop Tool



DDO-36A



DMC-001C



DDO-35



DDO-36

Hatch Equipment

S.E.E.S. #	O.E.M. #	Description
DHE-1	9769729, 45731, 69726	Switch , magnetic leveling, N.O., wires out of side Max. voltage 270 AC or DC
DHE-1A	9865743	Reed switch assembly , Replacement parts to repair Magnetic Leveling Switches DHE-1, DHE-2
DHE-2	9813421, 113204	Switch , magnetic leveling N.O., wires out of back. Max. voltage 270 AC or DC
DHE-3	9711557, 69290	Limit switch , 230V, normally closed
DHE-3A		Spring Hinge , for DHE3 and DHE-5
DHE-5	9711545, 115164, 105701	Limit switch , 230V, normally open
DHE-6	9768695	Tire for DHE-3, DHE-5 and DHE-4A
DHE-7	9706847	Plastic wheel without tire
DHE-8	9857072	Contact block , stationary for DHE-5
DDO-3	9892916	Contact block , for DHE-3
DPC-32A	298AG2	Auxiliary Contact Block , N.O/N.C.
DHE-4A	9755585	Limit Switch , D.P./N.C., DMC-1
DHE-200	9848903	Reed Switch Kit , [TIII]



DHE-1

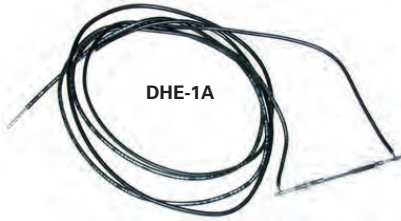

DHE-1A

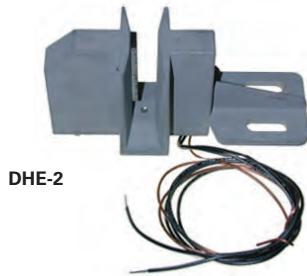

DHE-2



DHE-3A



DHE-200

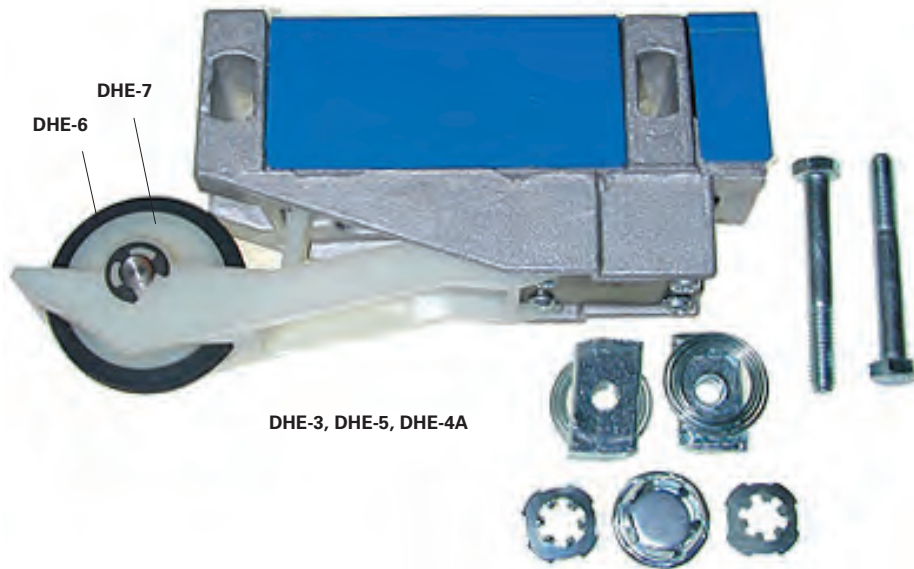

DHE-3, DHE-5, DHE-4A

DHE-7

DHE-6

Encoders and Tachometers

S.E.E.S. #	O.E.M. #	Description
DMP-16	9716154, 373AA1	Encoder flange mount, 2048 CPR
DDO-48	9716166	Encoder, 5VDC, 5000 CPR
DDO-49	9716520	Encoder assembly, flange mount, T4 and VVF geared, 2048 CPR, coupling (.5" x 3/8") included
DRP-33	9740521	Tachometer, Tandem Style
DMP-23	9849257	Tachometer, 50V, 1000RPM, foot mount, 1/2" shaft
DMP-200A	9875261, 9877228	Encoder, Positioning 5-28 V [This replaces the 373AR1]
DMP-200B	9719234	Encoder Regulator Kit, Includes Regulator Card, Brackets and Hardware
DMP-17	9780233	Flexible Coupling, for MM II Tachometer
DMP-17A		Coupling, 3/8" x 3/8"



DMP-16



DDO-48



DMP-200A



DRP-33



DMP-200B



DMP-17



DMP-17A



Machine Parts

Jack Packing for Dover

S.E.E.S. #	O.E.M. #	Description	Plunger Size
PAC-44	1A084-10, 9832907	Autopak for IVO-3S (includes "O" ring)	3-7/8"
DPAC-20	3EA023-01	Packing, Rotary Lift (2 Seals, Lantern Ring)	4-3/8"
DPAC-20A	3EA024-04	Packing, Set (2 Seals, Lantern Ring)	4-1/2"
DPAC-21	3EA023-02	Packing, Rotary Lift (2 Seals, Lantern Ring)	5-7/16"
DPAC-22	3EA023-03	Packing, Rotary Lift (2 Seals, Lantern Ring)	6-1/2"
DPAC-22A	3EA023-11, 9787239, 9870349	Packing, 3S, (Rota Seal & Wiper)	3-1/2"
DPAC-22B	9844600	Jack Seal Kit, 3T	
DPAC-22C	9851094	Packing, 3S, (Rota Seal & Wiper)	
DPAC-22D	9844612	Jack Seal Kit, 2.5T	
DPAC-23	3EA023-12, 9787240, 9705272	Packing, 4S, (Rota Seal & Wiper)	4-3/8"
DPAC-23A	4E003, 9787240, 9708467	Packing, 4S (Rota Seal Only)	4-3/8"
DPAC-24	3EA023-13, 9787252, 9705442	Packing, 5S, (Rota Seal & Wiper)	5-7/16"
DPAC-24A	4E004, 9787252	Packing, 5S, (Rota Seal Only)	5-7/16"
DPAC-24B	9851010	Jack Packing Parker, 5S	
DPAC-25	3EA023-14, 9787264, 9705612	Packing, 6S, (Rota Seal & Wiper)	6-1/2"
DPAC-25A	4E005, 9787264, 9708480	Packing, 6S, (Rota Seal Only)	6-1/2"
DPAC-25C	9743066	Packing, 7S, (Rota Seal & Wiper)	7-1/2"
DPAC-25D	10-72-R06500-LF10Z	Dover S Head	6-1/2"
DPAC-26	06-00S03000	Packing Set, holeless LF2 OZ packing set (1 jack)	3"
DPAC-29	9723821	Jack Wiper Ring, 3S	

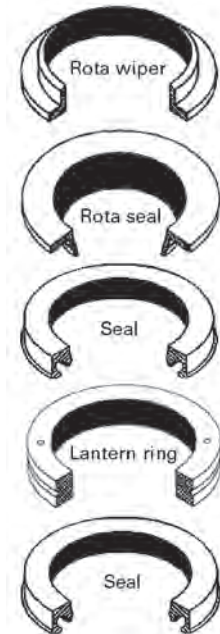

DPAC-21



DPAC-21A



DPAC-21B

Machine Seals

Designed for dependable service with ease of installation.
Heat and oil resistant material provides positive sealing performance.

S.E.E.S. #	O.E.M. #	Doover Worm Gear Seals	Seal Dimensions
DPAC-21A	5E006, 9767897, 76789, 9808644, 108644	Spider Seal , (Split), for GD-45	5-1/8" x 7" x 1/2"
DPAC-21B	9767894	Pedestal Shaft Seal for GD-45	5-1/8" x 7" x 1/2"
DPAC-25B	5E004, 9825526, 112733	Spider Seal , (Split) for GD-105	7-1/8" x 8-5/8" x 1/2"
DPAC-30A	1R043, 9763326, 76332 9752110, 75211	Worm Gear Seal , Split, with Deflector, machine # GD-45, GD-50, GD-75	1.749" x 2.650" x .500"
DPAC-31	1R002, 9825514 9752122, 26586	Worm Bearing Seals , Split with Deflector for GD-105, GD-200 and GD-240	2.345" x 3.220" x .500"
DPAC-31A	1R048	Worm Gear Seal , Split (Inner), for 1R048	4.5" x 5.5" x .625"
DPAC-31B	5E005, 9824479, 72447 9722701, 72270, 9808760, 108763, 108763	Spider Seal , (Split) for GD-50, GD-75, GD-200, GD-240 and GD-300	8-1/2" x 10-1/4" x 1/2"
DPAC-32	9779231, 77924	Worm Seal , Gland packing, for GD-300	3" x 4" x .500"
DPAC-33	9840503	Worm seal , for GDF-25	2" x 4.5" (flange) x .75"
DPAC-36	9857648	Worm seal , for GD1	



DPAC-27

S.E.E.S. #	O.E.M. #	Description
DPAC-27	9873200	Seal , Oil Output GD1, 5.256" x .438"
DPAC-28	9873223	Seal , Oil Worm with Carrier
DPAC-28A	9873223	Seal , Oil Worm
DPAC-31C	9824479	Pedestal side seal , for GD-240, GD-200, 4.88" x 6.25" x .5"
DPAC-34	9825538	Oil Seal , for GD 45, GD 105
DPAC-35	9740053	Adapter Seal , 10.125" for GD 105



DPAC-28



DPAC-34



DPAC-35

Bearings and Shims



DMP-1



DMP-3A



DMP-5A



DMP-6A



DMP-6B

S.E.E.S. #	O.E.M. #	Description
DMP-1	9818121	Shim , .002 red, GD45
DMP-1A	9818110	Shim , .005 blue, GD45
DMP-2	9745099	Shim , .002 red, GD75
DMP-2A	9745105	Shim , .005 blue, GD75
DMP-3	9812740, 112730	Shim , .002 red, GD105
DMP-3A	9812726, 112732	Shim , .005 blue, GD105
DMP-4	9778780	Shim , .002 red, GD240
DMP-4A	9778792	Shim , .005 blue, GD240
DMP-5	9880276, K91509	Thrust bearing for GD-45 machine, I.D. 1.875", O.D. 3.730", Thick. 1.224" x 2 + .250" Shim
DMP-5A	9767903	Spider shaft bearing set , GD-45 pedestal side
DMP-5B	9767915	Spider shaft bearing set , GD-45 ring & oil seal side
DMP-6	9702453, K91509	Thrust bearing for GD-105 machine
DMP-6A		Thrust Bearing Cover Gasket , GD105
DMP-6B	9812787	Gasket , D105 Adjustment cover GD105
DMP-7	9789807	O-Ring , (outboard) 4.012" x 3.734"
DMP-8	9715113	O-Ring , worm cover plate 4.9" x 5.2"
DMP-8A	9812763, 112758	O-Ring , GD-105 4.609" x 4.877"
DMP-9	9715101	O-Ring , thrust end 5.6" x 5.8"

Machine Parts

Bearings and Shims

S.E.E.S. #	O.E.M. #	Description
DMP-10	863230, 26323	Brass sleeve for brake assembly, 5.25" L x 2.625" O.D.
DMP-10A	9792790	Gasket , neoprene 2-1/2" O.D. x 2.15" I.D. x 1/16" thick, for DMP-10 Brass sleeve
DMP-11	98063242	Plunger for brake assembly 4.187" L
DMP-11A	9833316	Plunger for brake assembly 5.2" L
DMP-11B	9814286	Brake Solenoid Retrofit Kit Plunger , Sleeve & end plates
DMP-12	9715125	O-Ring , thrust end, 5.9" x 6.2"
DMP-13	9824820, 9830145	Thrust bearing set for GD-75-1
DMP-13A	9824856, 32485	Thrust bearing set for GD-75-2
DMP-14	9880288	Thrust bearing kit for GD-240, includes bearing set, shims, o-ring seal, washer, nut
DMP-14A	9778779	Thrust bearing for GD-240
DMP-14B	9778809	Inner bearing for GD-240
DMP-15	9813512	Oiler , felt wick
DMP-15A		Lubricator Wick , 22-1/2 lbs. - 30 lbs.
DMP-18	9723584	Dampening/Vibration Pad , 1" x 3.25" x 6"
DMP-19	9742906	Wick , Lubricator, felt formed to fit rail
DMP-21	9844636	Bearing Kit , Jack 2.5 T, 2.5"
DMP-24	9858214	Pad , ISO 6" x 3.25" x 2"
DMP-25	9754816	Pad , ISO with plug
DMP-26	9713154	Pad , ISO pad 5 pack
DDO-26	9705478, 70547	Rubber cushion , 2" O.D. x 1-1/2" brake pulley or machines GD-45, GD-50, GD-75, GD-105, GD-200, GD-240, GD-300
DDO-26A		Rubber cushion , brake pulley, 1-1/4" x 3/4" x 1-3/8" L
DDO-26B	20980	Shoulder bolt , Drum Bush For DDO-26
DMP-105-KIT		GD-105 Rebuild seal kit 15 pc. Less bearings
DMP-200	9863254 / 26325	Cork , Geared Solenoid Brake Pad, 5.25" x 2.875" x .125"
DMP-201	9772017	Bearing , for 66700 and 5501AE Governor
DMP-202	9833511	Inspection Cover , Geared Machine, Clear



DMP-10



DMP-11



DMP-11A



DMP-13



DMP-11B



DMP-18



DMP-24



DMP-25



DMP-26



DMP-200



DMP-201



DMP-202

Printed Circuit Boards

S.E.E.S. #	O.E.M. #	Description
DPC-71	9746250	Power Supply +5V @16A
DPC-77A	9773113	PCB Pushbutton, 48VDC Print# 6300KJ2
DPC-77B	9773101	PCB Pushbutton, 24VDC Print# 6300KJ1
DPC-118	9749160	Regulator Card PC Board
DPC-122	9781444	Power Log 24V PC Board
DPC-126	9803877	Door Operator Board
DPC-160	9816653	Current Regulator Board
DPC-154	9803889	UDC Tac PC Board
DPC-149	9716853	Digital Current Regulator T4 PC Board
DPC-158	9816380	Inverter T-IV PC Board
DPC-155	9813925	LSZ Card, T2 PC Board
DPC-166	9835842	Motor Field Regulator Board
DPC-159	9816392	QSR PC Board
DPC-207	9875247	Door Operator Board
DPC-208	9875851	Dover S5ST Speed Control
DPC-150	9755470	Snubber Board T-IV
DPC-165	9835647	Inverter Card PC Board
DPC-209	9815600	Processor PC Board
DPC-173	9816124	Board PC Board
DPC-174	9719817	Software DMC-1 CLC Type 12
DPC-161	9816770	IGBT PC Board
DPC-101	9716830	HDW/VAC. CON T4 PC Board
DPC-133	9839628	Optical Detector PC Board
DPC-135	9840266	Optical Level PC Board
DPC-136	9840965	Optical Emitter PC Board

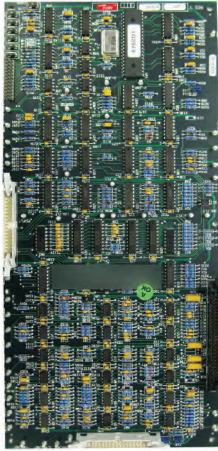

DPC-118

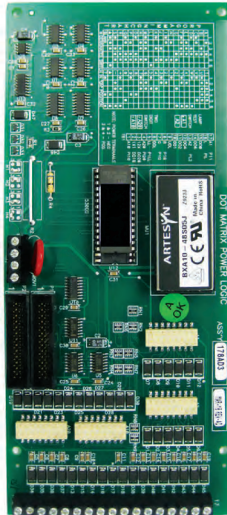

DPC-122



DPC-126



DPC-133



DPC-150

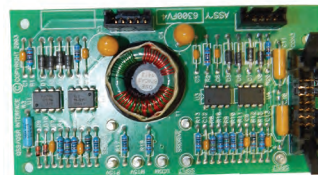

DPC-159



DPC-136



DPC-135



6ea. come with DPC-135

Printed Circuit Boards

S.E.E.S. #	O.E.M. #	Description
DPC-201	9841362	Optical Sensor, Lens & Fiber
DPC-202A	9781146	PC Board, Hall Node
DPC-202B	9782278	Power Supply, with Harness, DM
DPC-200	9823888	Locking Standoff, .5"
DPC-40C	9720315	Suppressor, Transient Assembly
DPC-206	9782813	PCB, I/O Exp., 24 VDC TAC20
DPC-207	9740375	PCB, Card Assy SPI Hi Voltage

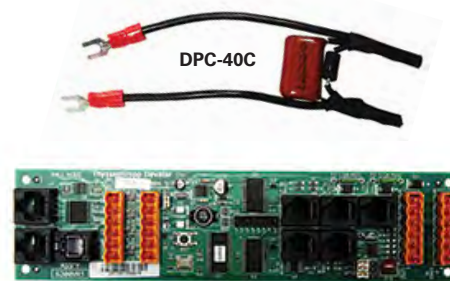

DPC-202A

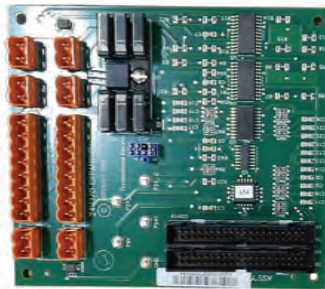

DPC-206

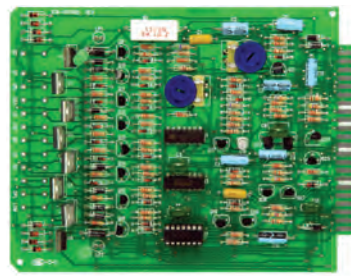

DPC-1A

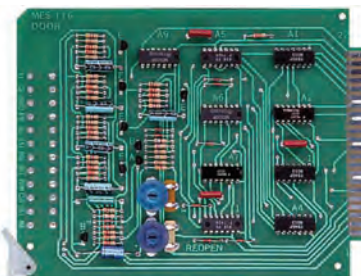

DPC-2A

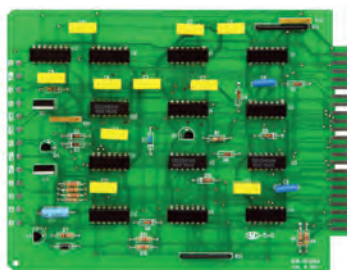

DPC-3A

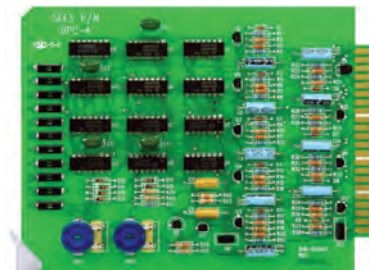

DPC-4

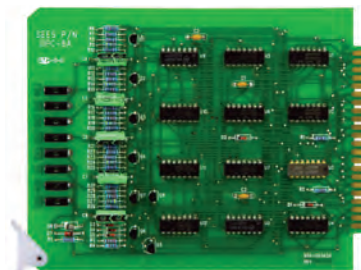

DPC-6A

Hydro PC Boards

S.E.E.S. #	O.E.M. #	Description
DPC-1A	68177, 9855245, 105248	Power PC Board, 4 slot
DPC-2A	68178, 9855233, 124519	Door PC Board, 4 slot
DPC-3A	68179, 9855221, 123948	Car PC Board, 4 slot
DPC-4	68180, 9781808	Logic PC Board, 3 slot
DPC-5	68433, 9884336	Duplex PC Board, 3 slot
DPC-6A	9805254, 105254, 68525	Option PC Board, 4 slot
DPC-7A	9855257, 105251, 6843, 6669	Top & bottom PC Board, 4 slot
DPC-8A	9855269, 105252, 68432, 68432, 66690, 10252	Intermediate PC Board, 4 slot
DPC-9	9781870, 111973, 68187	Reverse phase relay
DPC-30	9768324, 76832	Guide for PC Boards, black plastic
DPC-30A	106364, 106365	Base for DPC-1A, 22 pin socket

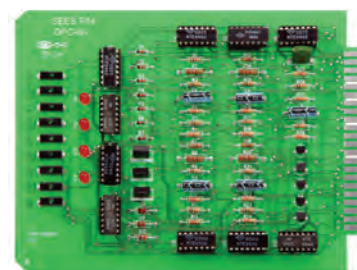

DPC-8A

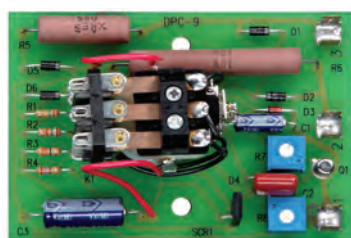

DPC-9



DPC-30

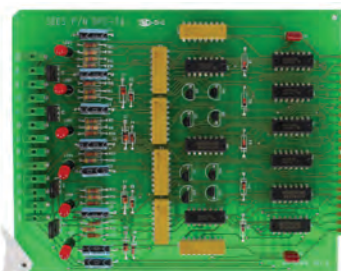

DPC-7A

Printed Circuit Boards

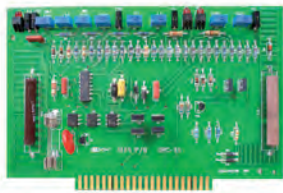

DPC-25



DPC-35

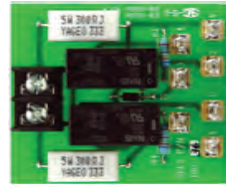

DPC-36

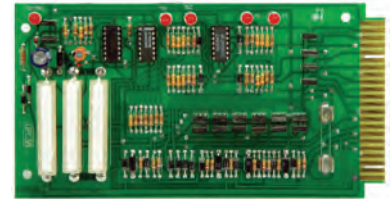

DPC-38



DPC-38A



DPC-39



DPC-39A



DPC-39A-D



DPC-39A-E



DPC-39C



DPC-39D



DPC-39H



DPC-39H-D



DPC-39H-E



DPC-45

Traction PC Boards

S.E.E.S. #	O.E.M. #	Description
DPC-25	9811989, 111980	Motor field, control PC board
DPC-35	9821170, 102117, 67416	Hall call, single relay PC Board, 48V
DPC-36	9821168, 102116, 67491	Hall call, double relay PC Board, 48V
DPC-38	9811266, 126125	Optical leveling, PC Board
DPC-38A	9834140	Optical Leveling Control PC Board Kit
DPC-39	9812258, 112267, 112264	Emmitter/Detector assembly, original version
DPC-39A	124945, 124942	Emmitter/Detector assembly, updated version
DPC-39A-D	124942	Detector PC Board, mounting holes .156" diameter
DPC-39A-E	124945	Emmitter PC Board, mounting holes .156" diameter
DPC-39B	125750	Base, mounting block for emitter & detector boards
DPC-39C	106365	Mounting bracket for DPC-39
DPC-39D	112264	Detector PC Board, mounting holes .125" diameter
DPC-39E	112267	Emmitter, PC Board, mounting holes .125" diameter
DPC-39F	9715460, 610AF1	Emmitter, photo emitter assembly module
DPC-39G	9715472, 610AE2	Detector, photo detector assembly module
DPC-39H	9840138	Emmitter/Detector assembly with amplifier and filter
DPC-39H-D	6300FC1	Detector, with transistor amplifier
DPC-39H-E	6300FD1	Emmitter, with noise filter
DPC-44	9853492	Power supply assembly 24 VDC OUT, 110 VAC IN
DPC-45	9853509	Power supply assembly 24 VDC, 6.25 amps

Printed Circuit Boards and Timers

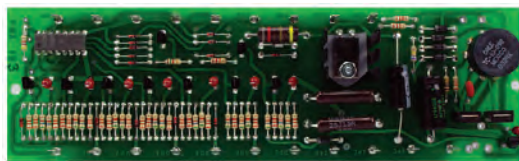

DPC-32



DPC-33-KIT

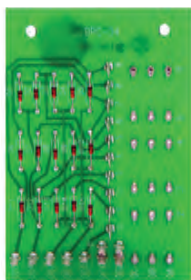

DPC-34

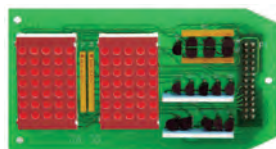

DB-35



DPC-37



DB-37

Car Signal PC Boards

S.E.E.S. #	O.E.M. #	Description
DPC-32	9811382, 9811370, 3329	Power supply card, up-upgraded version
DPC-33-KIT		PCB & PI LED Display
DPC-34	9813378, 9813366, 3332	Decoder assembly PC Board
DPC-37	9818420, 118412	Emergency light PC Board, LED version, for battery replacement order MIS-194B
DB-35	9835878, 178AC1	Position indicator display board
DB-37	9713232, 178AD2	Power board, logic, 24V
DB-38	9713244, 178AD1	Power board, logic, 48V



DPC-21



DPC-22



DPC-23

Timers

S.E.E.S. #	O.E.M. #	Description
DPC-21	9852037, 124566, 9852001, 9852803, 05201, 65280	Timer, 110 VAC, .1 - 260 sec. timing range
DPC-22	9852049, 124561, 9815284, 9852797, 101528, 65278, 68536, 9885365, 9805278, 105238, 102313	Timer, 20 - 60 VDC, .1 - 260 sec. timing range
DPC-23	9711934, 75301	Timer, 120 VAC, SPDT, 4.5 minutes timing range
DPC-24	9812611, 111261	Timer, for brake relay
DPC-27	9741306, 72533	Timer, 115 VAC, 120 sec timing range
DPC-28	9728375, 62837-1, 78230	Timer, 115 VAC, .1 - .25 sec. timing range, used on "SET" Traction
DPC-29	9728387, 62838-1	Timer, 230V max used on "TLT" and "TMT"
DPC-30	9955215	Timer, 24 VDC
DPC-31	9752810, 75281	Time delay relay, 115V, 60 cycle, 2 - 12 second timing range, octal plug in



DPC-24



DPC-27

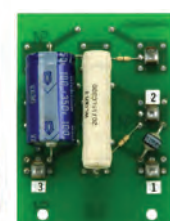

DPC-28



DPC-29



DRP-30



DPC-31

Printed Circuit Boards

DOVER

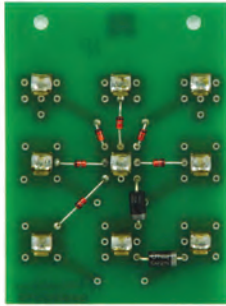

DPC-10

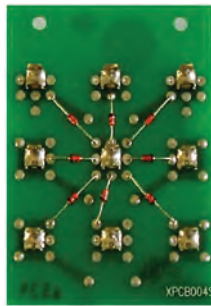

DPC-11

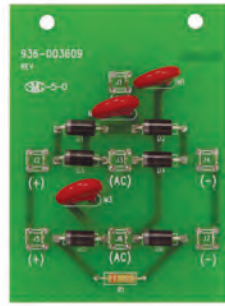

DPC-12

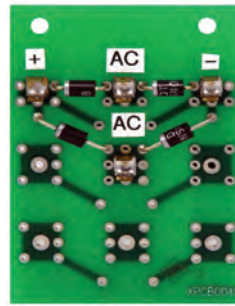

DPC-13

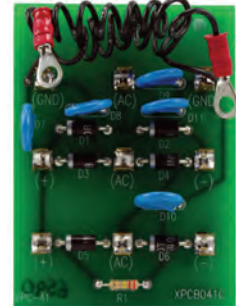

DPC-41

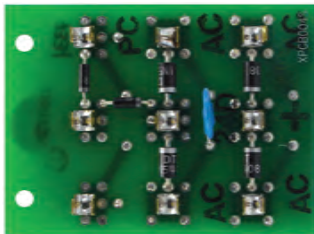

DPC-42

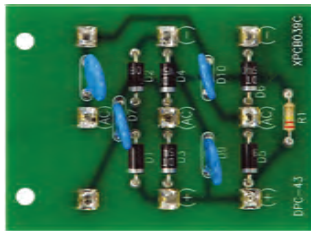

DPC-43

Rectifiers

S.E.E.S. #	O.E.M. #	Description
DPC-10	9892680, 69268, 69283	Zener, diode assembly with regulator
DPC-10A	9892692, 69269	Zener, diode assembly
DPC-11	9892679, 69267	Zener, diode assembly
DPC-12	9879675, 67967, 113149, 111207, 76785	Rectifier, 3 phase, to 300 VDC, 3 amp
DPC-13	9879810, 67968, 67981, 72109, 76824	Rectifier, single phase, to 300 VDC, 3 amp
DPC-41	9841246, 114129	Rectifier assembly, 3 phase, to 300 VDC, 3 amp
DPC-42	9892989, 113065, 67968, 69298, 111208	Rectifier assembly, 2-single phase full wave with diode arc suppressor, 24 volt supply
DPC-43	9715289, 9719842, 115298	Rectifier assembly, 3 phase, to 300 VDC, 18 amp
DPC-26	9841350, 114135	Protector assembly, door operator surge protection assembly
DPC-26A	9804420	Suppressor, Transient Assembly 220V
DPC-40	9856213, 65621	Thyrector assembly, 82V with spade lug
DPC-40A	9791619	Thyrector assembly, used on wire contact realy
DPC-40B	9719880 / 890AF1	Supressor assembly

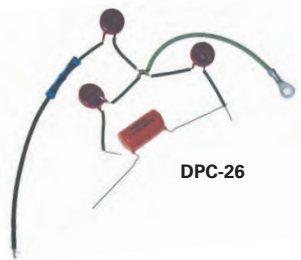

DPC-26



DPC-40



DPC-40B

Printed Circuit Boards and Timers -DMC



DPC-47 (FRONT AND BACK)



DPC-58



DPC-48



DPC-48A



DPC-49A



DPC-51



DPC-52



DPC-56



DPC-57MA

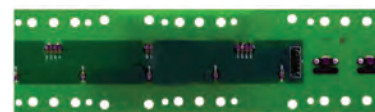

DPC-57



DPC-57M



DPC-59

S.E.E.S. #	O.E.M. #	Description
DPC-47	9841507	Power Supply, DMC, 5 VDC, harness not included
DPC-58	9741331	Card Auxiliary Sensor, for DMC 1 and T3
DPC-48	9841313	DMC-1 Selector, PCB 6300CV1/2
DPC-48A		DMC-1 Selector, PCB 6300CV3
DPC-49A	9832875	Door PC Board, HD98, TAC20, and TAC22
DPC-50	9832520	Power Supply, 5V
DPC-51	9816112	Power Supply, DMC, (2) +12, +5, -12 VDC
DPC-52	9853480	Power Supply, 15V 9 Amps
DPC-55	9804304	Power Supply, UPC 500 VAC
DPC-56	9753217	Card, option 6 slot
DPC-57	9841325	Card Sensor, main, DMC-1
DPC-57M		Magnet Holder for DPC-57
DPC-57MA		Magnet, 1.25" L x .365" Diameter
DPC-59	9715710	DMC-1 Card, CLC 6300BP4
DPC-61	9773125	Card, Call Register Light Assembly, 115 VAC
DPC-62	9816124	Power Supply, PCB 110 VAC 24 VDC Out TAC50
DPC-63	9782916	Serial Button Board 6300LL3
DPC-64	9773113	PCB, Lon Node, 6300LM1
DPC-65	9714911	Semiconductor, for GE Drive # 104X125DC061
DPC-137	9841301	Power Unit Relay
DPC-167	9836494	Power Unit Relay with Relays
DPC-171	9851379	Power Unit Relay without Relays



DPC-62



DPC-63

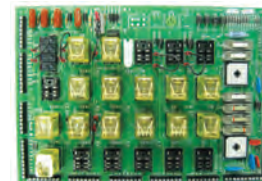

DPC-137



DPC-167

DOVER

Printed Circuit Boards

Magnetek

S.E.E.S. #	O.E.M. #	Description
DPC-189	9845872	Main, all ratings PC Board

ETSL

S.E.E.S. #	O.E.M. #	Description
DPC-178	9860125	ETSL PC Board

LMH

S.E.E.S. #	O.E.M. #	Description
DPC-179	9804298	Timer X Board
DPC-181	9804286	Control X Board

Load Weigher

S.E.E.S. #	O.E.M. #	Description
DPC-182	9841600	Load weighing Control, T IV

Loop Selector

S.E.E.S. #	O.E.M. #	Description
DPC-183	9833183	Terminal Slowdown Reed, (TFS), 4.7 Ohm, TIII
DPC-156	9813950	LSC PC Board
DPC-129	9836548	PCB, DMC Power Relay Board
DPC-184	9813937	LSS, Signal Shaper PC Board
DPC-185	9812398	LS8 PC Board
DPC-186	9816306	LS3 PC Board
DPC-187	9813779	LS1 PC Board
DPC-188	9812568	LS10 PC Board



DPC-124

DSP

S.E.E.S. #	O.E.M. #	Description
DPC-104	9719490	VVVF PC Board, without software, T IV, PC Board
DPC-109	9731817	VVVF, SW Vector, without software, T IV
DPC-138	9841349	SCR PC Board, without software T IV
DPC-198	9841349	PCB, Closed Loop BRG GE

MM II

S.E.E.S. #	O.E.M. #	Description
DPC-190	9780040	Field Regulator PC Board, 4 Quad

CPU

S.E.E.S. #	O.E.M. #	Description
DPC-134	9840114	Board ENH, Car, T IV
DPC-124	9782552	Board TAC20M
DPC-177	9782576	Board TAC20S

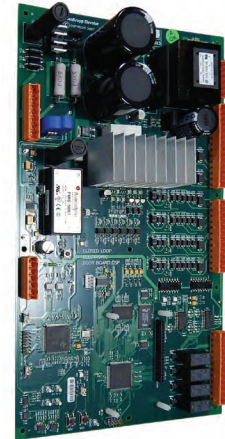

DPC-198

Printed Circuit Boards

T II

S.E.E.S. #	O.E.M. #	Description
DPC-197	9762218	I/O Transistor Output
DPC-198	9761627	I/O Input
DPC-164	9832063	Generator Field Half Bridge, Generator Field Module Assembly
DPC-199	9832051	Generator Field Module Assembly
DPC-200	9832026	I/O Call, I/O Module Assembly, Locking Standoff

T III

S.E.E.S. #	O.E.M. #	Description
DPC-148	9714881	RTG Board
DPC-144	9863000	PMI I/O Board, 48 Pos, without Modules
DPC-172	9853704	PMI I/O Board, 16 Pos, without Modules
DPC-143	9853686	Main Sensor Board
DPC-170	9841908	DDI PC Board
DPC-119	9760027	DAR-3 PC Board
DPC-202	9853832	Communication Interface, Car/Group
DPC-120	9760052	Regulator Board, Arm Volt 360

Signal Fixture

S.E.E.S. #	O.E.M. #	Description
DPC-131	9835210	LED, Lantern, Hall
DPC-157	9814050	Logic, Dot Matrix Position Indicator
DPC-163	9830431	Dot Matrix Display 1" Position Indicator
DPC-195	9830236	Dot Matrix Display 5/8"

MSC-1 and Model 3

S.E.E.S. #	O.E.M. #	Description
DPC-191	9740259	Tachometer Load Board
DPC-193	9840485	Power, with plug-in terminals, MSC-1

T IV

S.E.E.S. #	O.E.M. #	Description
DPC-102	9716841	Gate Driver, VVVF

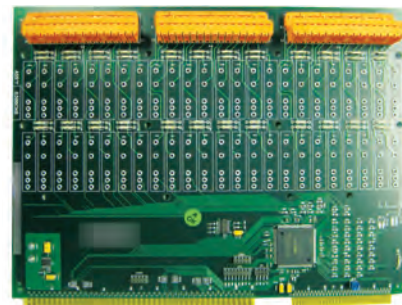

DPC-144

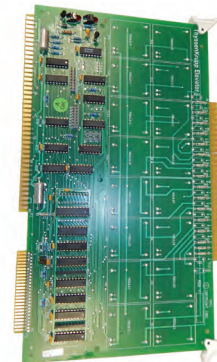

DPC-172

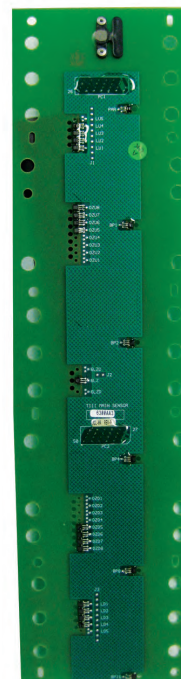

DPC-143



DPC-170

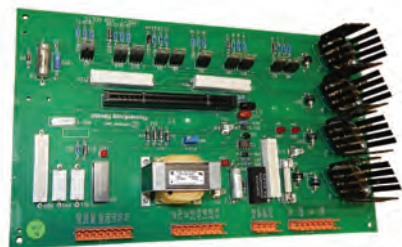

DPC-193



DPC-131

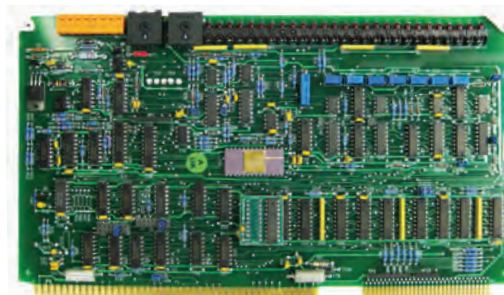

DPC-119

Rectifiers

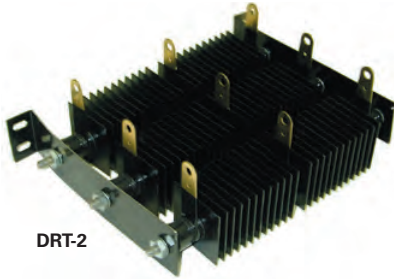

DRT-2



DRT-5



DRT-13-1

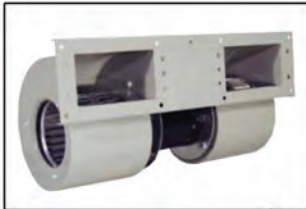

DRT-7-1

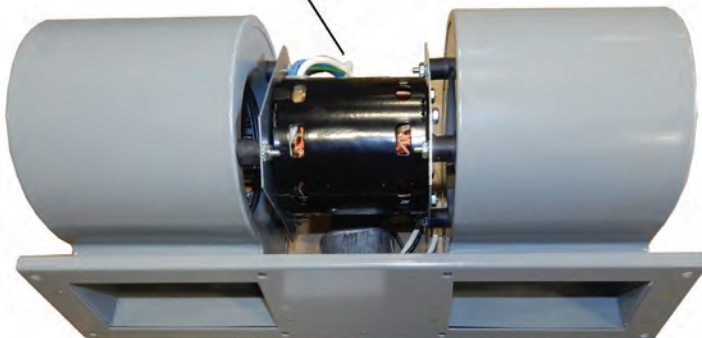

DRT-9



Fan / Blower

S.E.E.S. #	O.E.M. #	Description
DMP-20	378AT2	Fan / Blower , extremely quiet, rugged construction. 115 VAC 550 CFM capacity, for mounting in any position, for Dover VVF Equipment

S.E.E.S. #	O.E.M. #	Description
DRT-1	9719842	Doubler , 18 plates, 2.6" x 2.6"
DRT-2	9712082, 27858	Rectifier , Ladder network, 3 phase bridge, 72 plates
DRT-3	9756577	Power block , IGBT, 200 AMP
DRT-4	9756589	Power block , IGBT, 300 AMP
DRT-5	9851719	Rectifier , Toshiba IGBT block 300 AMP kit with thermal compound
MIS-CHEM-002		Thermal Compound , 3CC syringe
DRT-6	9756565	Rectifier , PRX IGBT block 150 AMP kit with thermal compound
DRT-7	9756577	Rectifier , PRX IGBT block 200 AMP kit with thermal compound
DRT-7-1	9756577	Rectifier , PRX IGBT block 200 AMP
DRT-8	9756589	Rectifier , PRX IGBT block 300 AMP kit with thermal compound
DRT-9	9717134	Rectifier , Toshiba IGBT block 100 AMP kit with thermal compound
DRT-10	147260, 9756553	Rectifier , PRX, 3PH kit with thermal compound
DRT-11	9717171	Rectifier , Toshiba IGBT block 150A kit with thermal compound
DRT-12	9717330	Rectifier , Toshiba IGBT block 200A kit with thermal compound (MIS-CHEM-002)
DRT-13	9756619	IGBT Block , 100 Amp @ 1200 VAC six pack drive block with thermal compound
DRT-13-1		IGBT Block , six pack 100 Amp, 1200VAC

Resistors

S.E.E.S. #	O.E.M. #	Description
DRES-1	9752857, 75285	100 Ohm 10 Watt
DRES-2	9879857, 47985	5K Ohm 10 Watt
DRES-3	9884282, 68428	250 Ohm 5 Watt
DRES-3A	9805310	8 Ohm 50 Watt
DRES-4	9818522	1.8k Ohms 100 Watt
DRES-5	9818534	3.6k Ohms 100 Watt
DRES-6	9818546	50 Ohms 100 Watt
RES-29	9744400	10K Ohm 50 Watt
RES-38	9744332	50 Ohms 100 Watt
RES-39	9744344	100 Ohms 100 Watt
RES-40	9744319	250 Ohms 100 Watt
RES-42	9744356	500 Ohms 100 Watt
RES-44	9744368	1,000 Ohms 100 Watt
RES-50	9734107	1 Ohm 200 Watt
RES-53	9744423	10 Ohms 200 Watt
RES-54	9720467	25 Ohms 200 Watt
RES-55	9720479	50 Ohms 200 Watt
RES-55A	9720480	75 Ohms 200 Watt
RES-56	9720492	100 Ohms 200 Watt
RES-59	9744435	250 Ohms 200 Watt
RES-60	9744447	500 Ohms 200 Watt
RES-61	9744459	1,000 Ohms 200 Watt
RES-62	9720509	2.5 K Ohms 200 Watt
RES-63	9720583	5 K Ohms 200 Watt

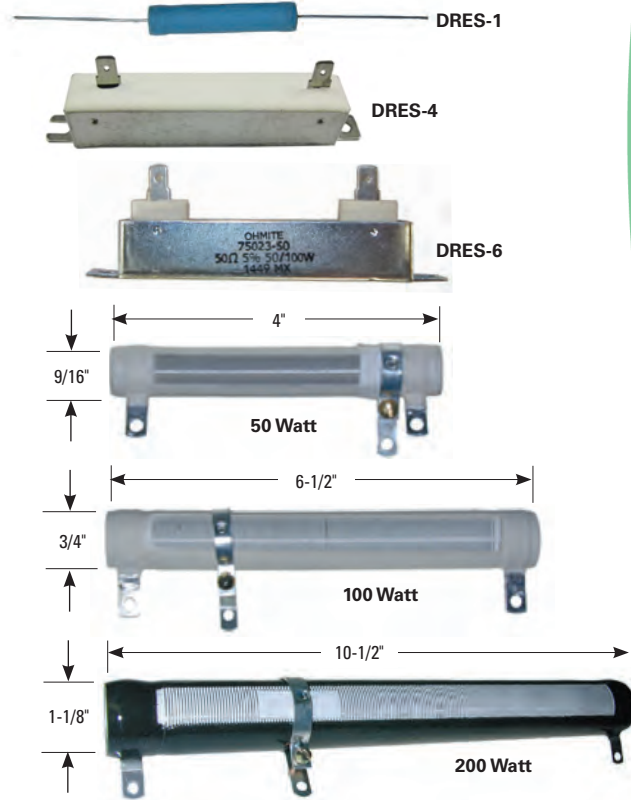

Relays

IBM Relays

S.E.E.S. #	O.E.M. #	Description
DRP-4	9791012, 109100	Relay, 32 VDC, 4 PDT
DRP-4S	769009	Solid State Replacement for DRP-4
PR-30	9767540, 76754, 769489	Relay, 48 VDC, 4 PDT
PR-30S		Relay, 48 VDC, 4 PDT W/LED solid state, alternate to PR-30
PR-30-S	769489	Relay, Solid State IBM 4 Pole 48 VDC
PR-31D	9756711	Relay, with diode arc suppressor, 45 VDC, 6 PDT
PR-31-S	769019	Relay, Solid State IBM 6 Pole 48 VDC
PR-33-S	186685	Relay, Solid State IBM 4 Pole Latching relay, 48 VDC
PR-34-S	769488	Relay, Solid State IBM 12 Pole
DRP-36	9787769	Relay, Card, G6B SPST 5A 690BX5
DRP-37	9718941	Relay, DC to AC T-4-IN



PR-30-S



PR-33-S



PR-31-S

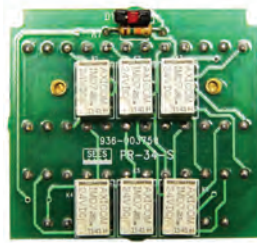

PR-34-S



DRP-36



DRP-37

Relays

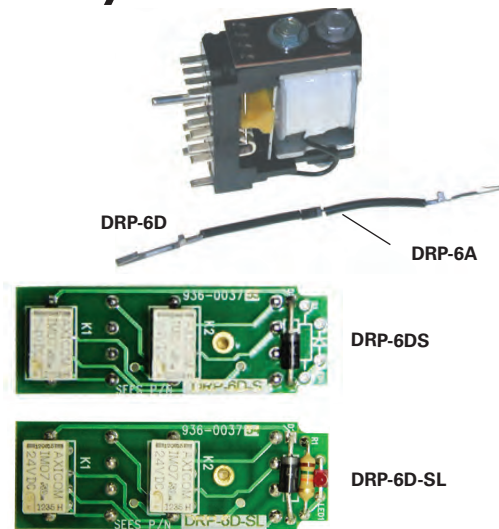

IBM Relays w/ Diode Arc Suppression

S.E.E.S. #	O.E.M. #	Description
DRP-6A	9856286, 65628, 9842081	Diode arc suppressor, diode with leads
DRP-6B	65261, 9852610	Diode assembly with leads for base
DRP-6D	9708960	Relay, with diode arc suppressor, 48 VDC, 4 PDT
DRP-6DS	9708960	Solid State Replacement for DRP-6D
DRP-6D-S	9708960	Relay, 4 PDT Solid State 48 VDC relay with Diode
DRP-6D-SL	9708960	Relay, 4 PDT Solid State 48 VDC relay with Diode & LED
PR-31D	9756711, 65671	Relay, with diode arc suppressor, 45 VDC, 6 PDT
PR-34D	9756723, 65672	Relay, with diode arc suppressor, 45 VDC, 12 PDT

IBM Relay Accessories

S.E.E.S. #	O.E.M. #	Description
PR-35	9767654, 76765, 159941	Receptacle, base for 4 PDT relay
PR-35C	9767678, 76767, 159942	Receptacle, base for 6 PDT relay
PR-35D	9767630, 76753, 159943	Receptacle, base for 12 PDT relay
PR-28-BC	9710322	Clip, bottom hold down clip for relay
PR-28-TC	9710310	Clip, top hold down clip for relay
PR-35A	149878	Contact, wire (not pictured)
PR-35L6	9702519	Jumper, insulated wire with taper pins 6" O.L.
PR-35L10	9702532	Jumper, insulated wire with taper pins 10" O.L.
PR-35L18	9702556	Jumper, insulated wire with taper pins 18" O.L.
PR-35T	9702611	Tool, for contact removal or insertion
MIS-301T		Universal Relay Tester For IBM style relays



DP Normally Open Front Connected Power Relays

S.E.E.S. #	O.E.M. #	Description
DRP-7	9769018, 76901	Relay with magnetic blowout, DPST, 48 VDC
DRP-14	9713256	Relay, DPST, N.O., 120 VAC
DRP-11	9768257	Relay, DPST, N.O., 24 VDC
DRP-8	9769020, 76902	Relay, DPST, N.O., 48 VDC
PR-101	9721733	Relay, DPST, 110 VDC
DRP-16	9753084	Relay with magnetic blowout, DPST, 6 VDC
DRP-13A	9909151	Relay with magnetic blowout, DPST, 12 VDC
DRP-14A	9741008, 71924	Relay with magnetic blowout, DPST, 120 VAC
DRP-12A	9740145, 72014	Relay with magnetic blowout, DPST, 110 VDC

Relays

DPDT Normally Closed Front Connected Power Relays

S.E.E.S. #	O.E.M. #	Description
PR-5	9752006, 75200	Relay, DPDT, 12 VAC
DRP-5A		Relay with magnetic blowout, DPDT, 48 VDC
PR-2	9768269, 76826	Relay, DPDT, 24 VDC
DRP-2	9768993, 76899	Relay, DPDT, 48 VDC
PR-7	9713207, 71922	Relay, DPDT, 120 VAC
PR-3	9713360, 72015	Relay, DPDT, 110 VDC
PR-9	9713219, 71923	Relay, DPDT, 240 VAC
DRP-13	9776357, 9776345	Relay with magnetic blowout, DPDT, 12 VDC
DRP-15	9755240, 75524	Relay with auxiliary contacts, DPDT, 120 VAC



DRP-5A



DRP-9



DRP-13

Field Protection Relay

S.E.E.S. #	O.E.M. #	Description
DRP-21	9764010, 76401 9769092	Field Protection Relay, current sensitive, pull in .75 amps, drop out .3 amp, operate 25.0 amp
DRP-9	9741884	Reverse Phase Relay, 440 VAC
DRP-9A	9834612	Reverse Phase Relay, 220 VAC
DRP-9B	9832555	Relay Monitor, reverse phase, 230 VAC



DRP-21



DRP-9A



DRP-17



DRP-18B



DRP-18E

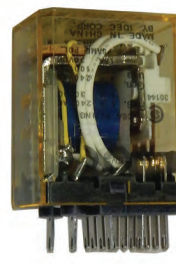

DRP-200



DRP-19A

DPDT 10 Amp Plug-in Relays

S.E.E.S. #	O.E.M. #	Description
DRP-17	9728648, 9783398, 132909	Relay, DPDT, 24 VDC, with diode
DRP-18	9832427, 9811060, 132426	Relay, DPDT, 110 VDC, with diode
DRP-18A	9783295, 132908	Relay, DPDT, 12 VDC, with diode
DRP-18B	9791061	Relay, 4PDT, 24 VDC, with diode and LED
DRP-18C	9811060	Relay, 4PDT, 110 VDC, with diode
DRP-18E	RH2B-ULC-AC120	Relay, DPDT, 10A, 120 VAC
DRP-19S		Relay, 6PDT, 48 VDC, Solid State
DRP-19A	9719970, 171AH1	Relay, DPDT, 48 VDC with push to test and lamp
DRP-19B	9953887	Relay, DPDT with diode, 48 VDC
DRP-19C	9951854	Relay, 110 VDC, DPDT w/ Neon Indicator
PR-102SS	HG2-SS	Socket, solder terminal for DP relay
DRP-200	9954922	Relay, 4PDT, 120 VAC
DRP-201	9954922	Relay Finder, 24 VDC



DRP-19S

■ 3/16" quick connect terminals for plug-in socket capability



DRP-19B



PR-102SS

Relays

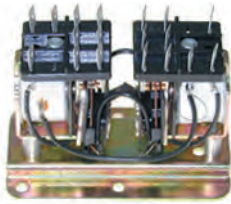

DRP-1



DRP-22



DRP-22F



DRP-22J

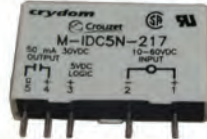

DRP-22K



DRP-25



DRP-26

Dual Coil Mechanical Latching Relay

S.E.E.S. #	O.E.M. #	Description
DRP-1	9724140	Latching relay, 2 sets 3 PDT, 240 VAC, door reverse function
DRP-10	9753047, 9813809	Latching relay, 2 sets 3 PDT, 120 VAC, door reverse function

S.E.E.S. #	O.E.M. #	Description
DRP-22	9853352, 518AC1	Output module, 24 VDC, black
DRP-22A	9851847, 518AF1	Output module, 200 VDC, black
DRP-22B	9853340, 518AB1	Input module, 90 VAC to 140 VAC, black
DRP-22C	9853339, 518AA1	Input module, 10 VDC to 32 VDC, black
DRP-22D	9853364, 518AD1	Output module, 120 VAC, black
DRP-22E	9719349, 518AK1	Output module, 280 VAC, black
DRP-22F	9719374, 518AJ1	Output module, 60 VDC, red
DRP-22G	9719362, 518AH1	Input module, 90 VAC to 140 VAC, yellow
DRP-22H	9719350, 518AG1	Input module, 10-48 VDC, white
DRP-22J	9852931	Module, I/O, DC Output 10-200V 4-Pin
DRP-22K	9809820	Module, I/O, DC Input 18-60V 5-Pin

DRP-25	9723780	Relay, 2P, 12V
DRP-26	9708091	Relay, 2P, 24V
DRP-27	9953711	Relay, IDEC 24 VDC
DRP-29	9840643	Relay, O/L, 45-90 Amp manual reset
DRP-35	9782195	Overload Relay, Solid State



DRP-27



DRP-29

Contactors



DRP-23



DRP-24



DRP-32



DRP-31

A.C. Reversing Contactor

S.E.E.S. #	Description
JC-7	Reversing contactor, 208-240 VAC, 50-60 Hz, 160 pick up volts, 680 ohms resistance D.C. 6" L, 3-3/4" W, 3" H with auxiliary contact

■ This reversing contactor is mechanically and electrically interlocked for low cost motor reversing applications. It is the first choice for door open/close function because of its proven reliability. Standard assembly includes mechanical interlock with four SPDT auxiliary contacts for electrical interlocking. Mounting bracket allows for easy installation. Double 1/4" quick connects on each coil terminal and easy access quick connects on right hand contactor with screw terminals on left hand contactor assure installation ease.

A.C. Contactor

S.E.E.S. #	O.E.M. #	Description
DRP-23	9853110	Contact, 4 Pole N.O. 24A, 120 coil for TIII
DRP-24	9837243	Relay, reversing, square "D" 120 VAC
DC-21	9817475	Contact, 3 Pole, 18.5KW, 400 VAC, 30 HO
DRP-31	9738289	Relay Part, for Overload heater
DRP-32	9722713	Contact, 3 Pole Siemens 42EF35AF
DRP-32B	298AG2	Interlock, Mechanical

Contactors

D.C. Contactor and Components

FOR #14 AND #15 SWITCHES, 100 AMPS AT 12VDC

S.E.E.S. #	O.E.M. #	Description
DRP-20	9871184, 77118	Contactor , 48 VDC coil, Single pole, double throw, make before break contacts, for #15 Switch
DRP-20A	9871196, 77117	Contactor , 48 VDC coil, Single pole, double break contacts, for #14 Switch

S.E.E.S. #	O.E.M. #	Description
DRP-20B	35893	Moving core
DRP-20C	35902	Guide , core
DRP-20D	36926	Fixed core
DRP-20E	10150	Core tube
DRP-20F	10152	Bushing for core tube
DRP-20G	35892	Guide stud
DRP-20H	35891	Bolt for movable assembly
DRP-20I	10074	Cradle block
DC-15	9759001	Stationary contact , normally closed
DC-16	9758902	Movable contact
DC-17	9759098	Stationary contact , normally open
DC-18	9758872	Spring , contactor, 8 turns
DC-19	9758884	Spring , contactor, 6 turns
DCO-4	9758940	Coil , 48 VDC. 1" I.D. x 2" O.D. x 2" L. Replacement coil for #14 & #15 Switches



Starter Assembly

S.E.E.S. #	O.E.M. #	Description
DPC-117	9747333	Starter assembly , Size 2-3, Y-MS, used on 147283 contactor

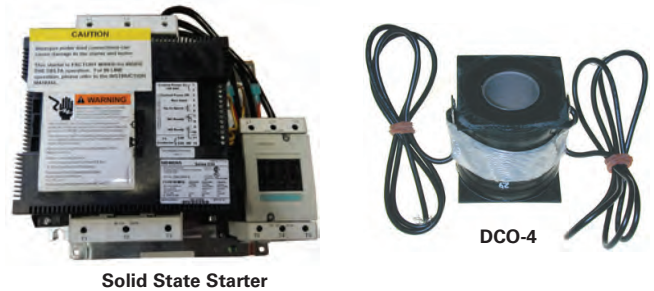

Solid State Starters

Selection Guide

S.E.E.S. #	O.E.M. #	Hydro 200V	Traction 200V	Hydro 220V	Traction 220V	Hydro 230V	Traction 230V	Hydro 380/400V	Traction 380/400V	Hydro 415V	Traction 415V	Hydro 460V	Traction 460V
MIS-NOR-004	9739040	5-15 HP	5-10 HP	5-15 HP	5-10 HP	5-20 HP	5-15 HP					5-40 HP	5-30 HP
MIS-NOR-005	9739051	20 HP	15 HP	20 HP	15 HP	25 HP	20 HP	40 HP	30 HP	40 HP	30 HP	50 HP	40 HP
MIS-NOR-007	9739087	25-30 HP	20-25 HP	25-30 HP	20-25 HP	30-40 HP	25-30	50 HP, 60 HP	40 HP, 50 HP	50 HP, 60 HP	40 HP, 50 HP	75 HP	60 HP
MIS-NOR-008	9739099	40 HP	30 HP	40 HP	30 HP	50 HP	40 HP	75 HP	60 HP	75 HP	60 HP	100 HP	75 HP
MIS-NOR-009	9739129	50 HP	40 HP	50 HP	40 HP	60 HP	50 HP			100 HP	75 HP	125 HP	100 HP

For additional Solid State Starters, see page 301.

Safety Edge Equipment

Item	S.E.E.S. #	O.E.M. #	Description
1	DSE-4	9873971, 47397	Auxiliary mounting arm
2	DSE-5	9874136, 120854	Switch assembly, L.H. for safe edge
	DSE-5A	9874586, 120853	Switch assembly, R.H. for safe edge
	DSE-6	9775535, 47553	Micro Switch, BZ-2RD-D82, quick connect
	DSE-6A	9750447	Micro Switch, BZ2RS-A2
	DSE-6B		Bracket for Micro Switch
	DSE-6C	9775535	Micro Switch, BZ-2RD-A2, screw terminal
3	DSE-8	9701461, 40146	Retractor spring
4	DSE-1B	44693	Mounting strip, steel
5	DSE-13	9851320	Spacer
6	DSE-14	9861415, 66141	Bumper
7	DSE-1S	9701837	Stiffener, 81-3/4" long U channel
8	DSE-3	9818248, 118249	Actuating arm assembly
9	DSE-3A	9801110, 40111	Shaft, roller pin for DSE-3 Actuating arm assembly
	DSE-15A	9732548, 77008	Bearing rod end, R.H.
10	DSE-15B	9732550, 77009	Bearing rod end, L.H.
11	DSE-16	102208	Screw, hex head 3/8-24 x 1-3/4" L
12	DDO-30	9747035, 44703	Rod attachment
	DSE-7	9774087, 47408	Ball bearing
	DSE-2	9735963, 100848	Retainer, Socket head screw
	DSE-12	9874392, 47439	Nut, Safety edge mounting arm nut, outer, on DSE-3
	DSE-11	9874045, 47404	Nut, Safety edge mounting arm nut, inner, on DSE-3
13	DSE-1L	9822276, 122217	Rod link, 21", R.H. & L.H.
14	DSE-17		Cable, 4 conductor, 18 gauge
	DSE-15	9701849	Rod, connecting rod assembly for Safety Edge 63899 Older Style. (Not DSE-9, DSE-10, pictured here)

SEES Light Curtain

S.E.E.S. #	Description
SEES-SCREEN-001B	SEES Screen II, Light Curtain, blue/red combo, 120 VAC
SEES-SCREEN-001G	SEES Screen II, Light Curtain, green/red combo, 120 VAC
SEES-SCREEN-001N	SEES Screen II, Light Curtain, Door Edge with Nudging Power Supply
SEES-SCREEN-001NC	SEES Screen II, Nudging Power Supply Only
SEES-SCREEN-001C	SEES Screen II, 120 VAC Controller Only
SEES-SCREEN-001R	SEES Screen II, Receiver Only
SEES-SCREEN-001T	SEES Screen II, Transmitter Only
SEES-SCREEN-001-MOVFR-CH	SEES Screen II, Light Curtain Direct Connect MOVFR, with Chip
SEES-SCREEN-001-MOVFR	SEES Screen II, Light Curtain Direct Connect MOVFR, without Chip
SEES-SCREEN-002	SEES Screen II, Light Curtain Waterproof
SEES-SCREEN-002N	SEES Screen II, Light Curtain Waterproof, with Nudging

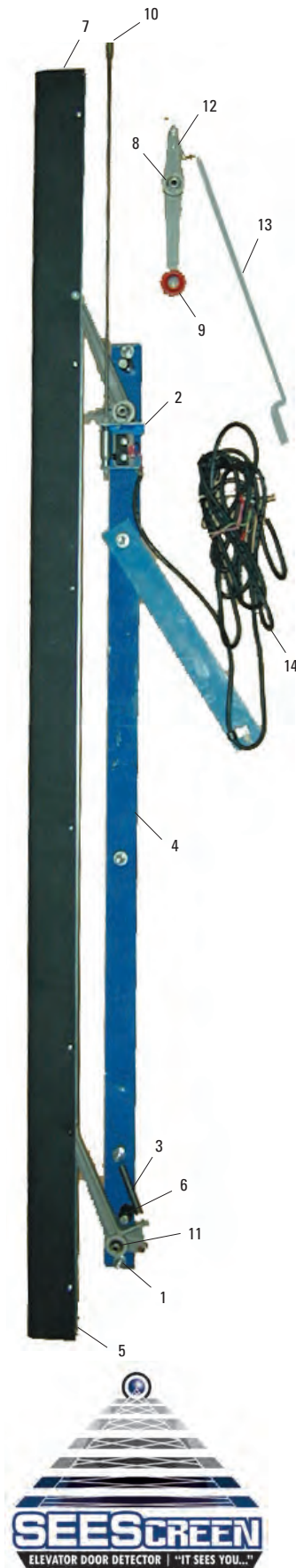

Safety Edge Equipment

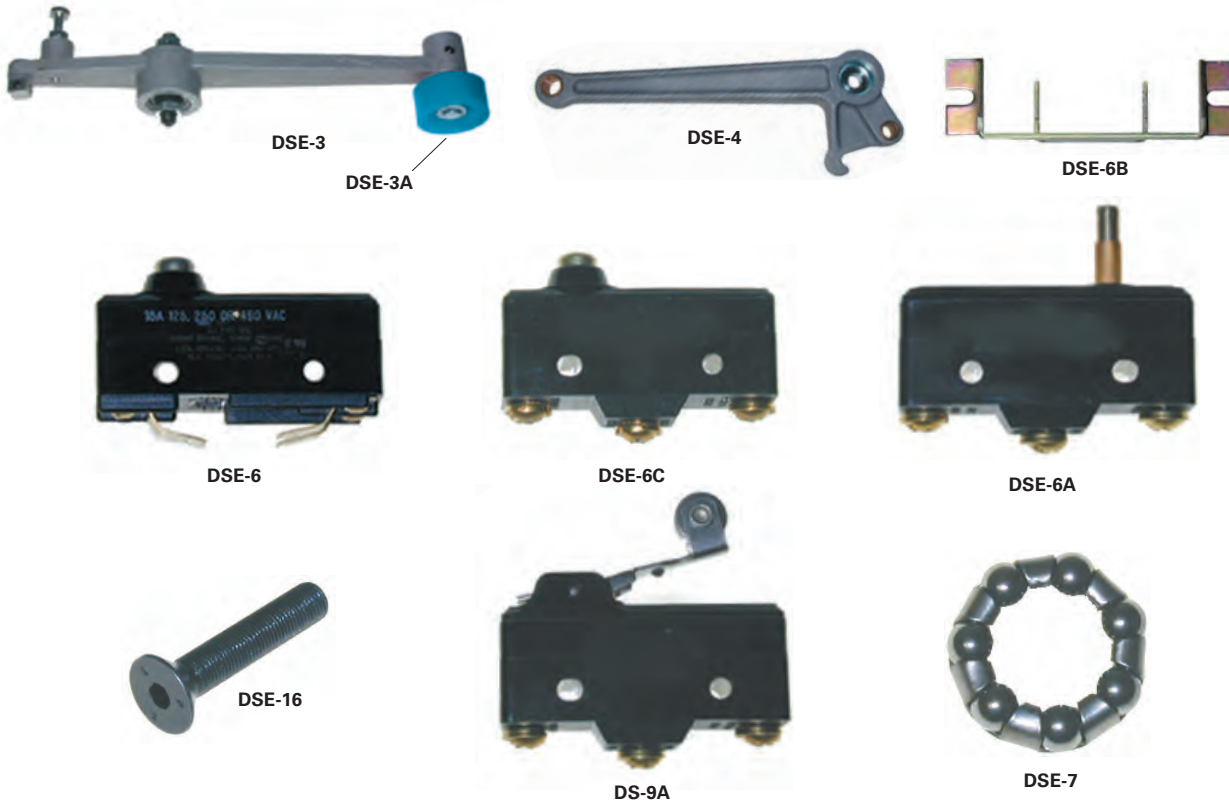

S.E.E.S. #	O.E.M. #	Description
DSE-3	9818248, 118249	Actuating arm assembly
DSE-3A	9801110, 40111	Shaft , roller pin for assembly
DSE-4	9873971, 47397	Auxiliary mounting arm
DSE-2	9735963	Screw , retainer 1/4-20, for DSE-4
DSE-13	100549	Spacer , for DSE-4
DSE-6	9775535, 47553	Micro Switch , BZ-2RD-D82, quick connect
DSE-6C	9775535	Micro Switch , BZ-2RD-A2, screw terminal (original version)
DSE-6A	9750447	Micro Switch , BZ-2RS-A2
DSE-6B		Bracket , for Micro Switch
DSE-16	102208	Screw , hex head 38-24 x 1-3/4" L used in conjunction with DSE-4
DS-9A	9758896, 75889	Micro Switch with arm and roller for safety edge
DSE-7	9774087, 47408	Bearing , for DSE-3 and DSE-4 ball bearing for pivot arms
DSE-8	9701461, 40146	Retractor spring
DSE-11	9874045	Nut , for safe edge inner arm
DSE-12	9874392	Nut , for safe edge outer arm
DSE-13	100549	Spacer , for stiffener, 1/4-20 internal threaded for DSE-2 screw
DSE-14	9861415, 66141	Bumper , eccentric rubber bumper



Selector Parts

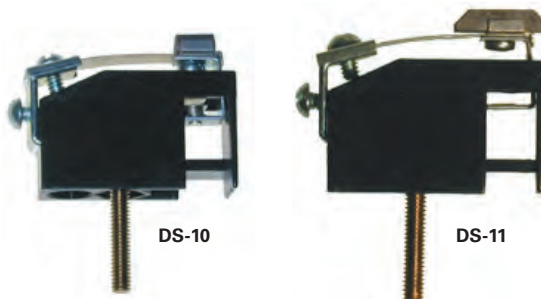
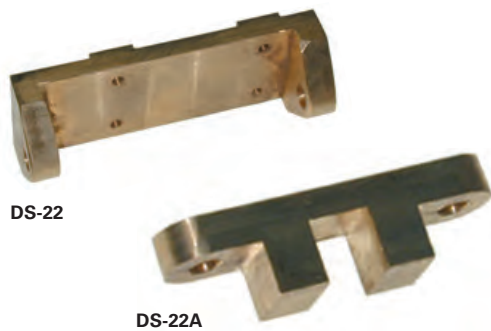
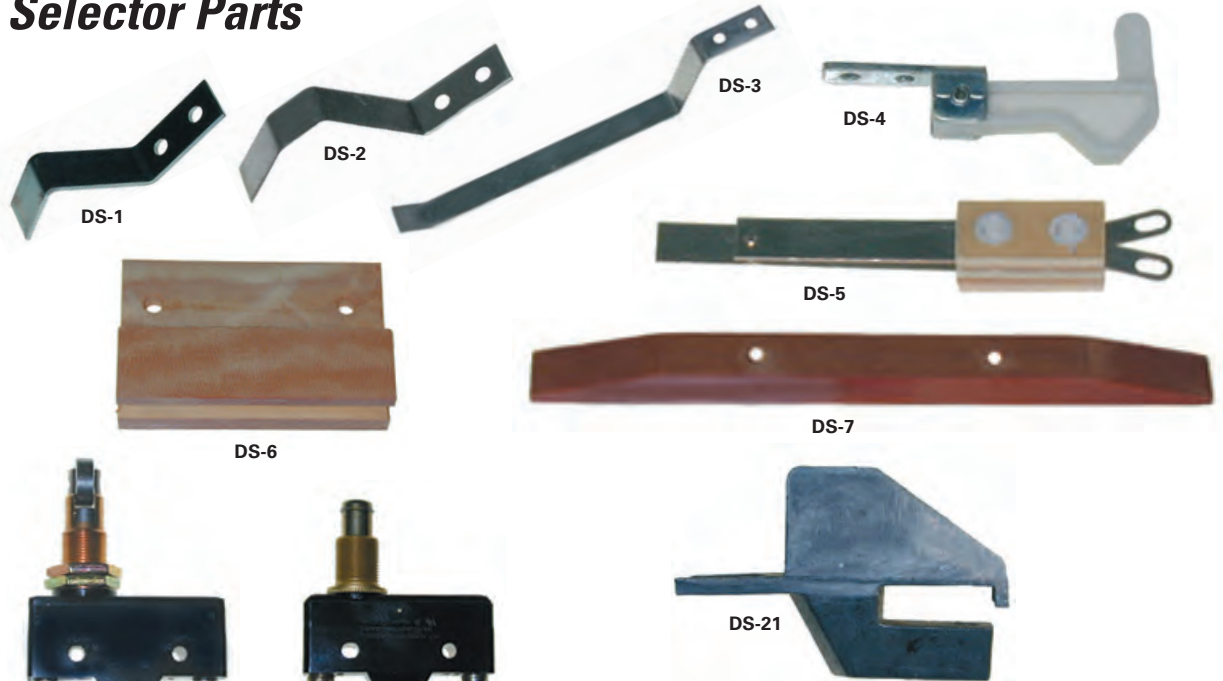

S.E.E.S. #	O.E.M. #	Description
DS-1	9722191, 22219	Short contact , 2-19/64" x 1/2"
DS-2	9722415, 22241	Medium contact , 2- 51/64" x 1/2"
DS-3	9722233, 22223	Long contact , 6-1/8" x 1/2"
DS-4	9748672	T.M. Switch actuator cam assembly for screw type selector
DS-5	9870556, 77055	T.M. Switch contact assembly with silver contacts
DS-5A	9889474, 68947	T.M. Switch assembly includes DS-4 and DS-5
DS-6	9772087, 22206	Guide for channel type selector, 3" x 2" x 7/8" with 3/8" slot, made of durable canvas base phenolic
DS-7	9822264, 22226	Cam for channel type selector, 6-3/8" Long
DS-8	9870570, 77057	Micro Switch , roller activated for carriage assembly on screw type selector
DS-9	9715642, 71565	Micro Switch for channel type selector
DS-10	9748623, 64862	Direction Switch , 5/16" L carbon contact and breaking silver to silver contacts, for floor bar assembly on screw type selector
DS-11	9848617	Brush Switch , 21/32" L carbon contact, (no silver contacts) for crosshead on screw type selector
DS-21	9846086, 41416	Selector clamp , aluminum, for microswitch
DS-22	9765645	Bracket , leveling ring mounting bronze bracket
DS-22A	102184	Bracket , lower leveling ring mounting bronze bracket
CKDS-1	101335	Contact Kit , Carbon Replacement For DS-11, 12 & 13

Selector Parts

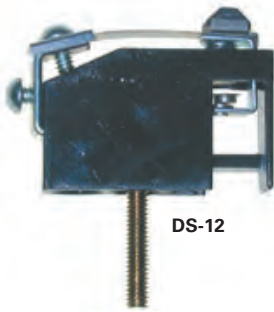

DS-12



DS-13



DS-14



DS-14A



DS-15



DS-15A



DS-16B



DS-17

S.E.E.S. #	O.E.M. #	Description
DS-12	9848539	Brush Switch assembly , 5/16" L carbon contact with breaking silver to silver contacts, for crosshead on screw type selector
DS-13	9848605	Brush Switch assembly , 5/16" L carbon contact, (no silver contacts) for crosshead on screw type selector
DS-14	9871317	Make break contact assembly , used on carriage assembly on screw type selector
DS-14A	9714390, 41439	Spring , bronze kick-off spring, 9/16" O.D. x 1"
DS-15	41424	Carbon plunger with 8-32 threaded brass stem, 2-3/4" L
DS-15A	9856791	Reset contact assembly complete
DS-16	D-320, 9763673	Leveling cam
DS-16B	9763636, 106363	Cap for leveling cam
DS-17	9813895, 41388	Leveling cam for 100:1 ratio, screw type selector, 300 feet, max. travel
DS-17B	9822446	Interlock Conversion Kit , Center Opening
DS-18	9714339, 41433	Floor bar contact used for screw type selector, 1-3/8" L with 8-32 thread
DS-18A	9714376, 41437	Contact insulator (back)
DS-18B	9714364, 41435	Contact insulator (front)
DS-18C	9950862, 41436	Contact insulator
DS-18D	9950837	Contact insulator , mount
DS-19	9722038, 22205	Washer , phenolic 5/8" O.D. x 1/4" I.D. x 1/8"
DS-48	9870179	Sensor , Optical 10-30 VDC Fiber Optic 10" Leads



DS-18



DS-18A



DS-18B



DS-18C



DS-18D



DS-48

Selector Parts

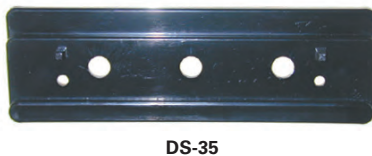
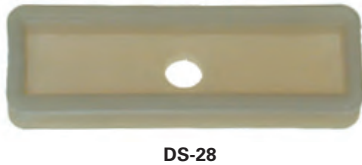
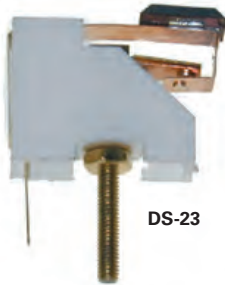
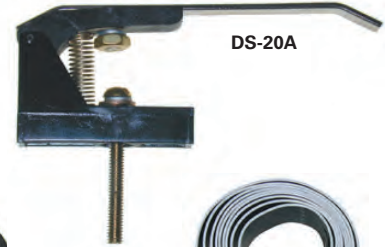
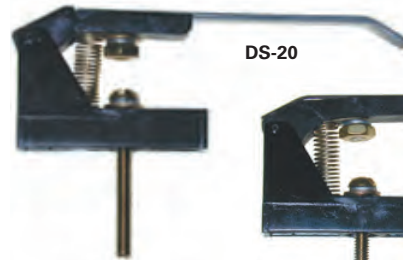

S.E.E.S. #	O.E.M. #	Description
DS-20C	9729045	Carbon ski contact 3-1/2" replacement contact for conducting butt brush assembly, used on assembly 9729045
DS-20D	9729057	Carbon ski contact 3-1/16" replacement contact for insulated butt brush assembly, used on assembly 9729057
DS-20	9879092, 9856833	Position Indicator brush assembly with insulated butt, brass surface
DS-20A	9897719	Position Indicator brush assembly conducting butt, brass surface
DS-23	9823360, 102336	Switch assembly , long, 11/16" carbon contact
DS-24	9813380, 101330	Switch assembly , short, 5/16" carbon contact
DS-25	9768932, 68932	Cable assembly , 36 conductor ribbon cable, 122" L, with quick connect plugs each end
DS-27	114104	Flat cable , 18 conductor ribbon cable, 96" long with pins
DS-26	106328	Pivot for selector guide shoe
DS-28	9842068	Crosshead guide shoe 2-1/4" L x 3/4" W
DS-29	9859998, 65999	Cam , direction selector
DS-30	9841441	Leveling guide
DS-31	9870600, 77060	Bearing , flange 1-1/4"
DS-32	9870593, 77059	Bearing , flange 3/4"
DS-35	9841544	Selector tape guide , 4" L x 1-1/4" W, plastic, Sold Separately
DS-35A		Selector tape guide , Brass, Heavy Duty version of DS-35. Sold Separately
ES-001	9745312	Vane Magnetic Selector tape , ELGO Selectors, Absolute Positioning for Dover/Thyssen

Selector Parts



S.E.E.S. #	O.E.M. #	Description
DS-33	9763818, 68953	Switch assembly , slack cable
DS-33A	127595	Contact , stationary for DS-33
DS-34	9847730, 66354	Idler sheave , 5-1/2" O.D. x .6693" I.D. for 1/8" cable, MIS-300
DS-34A	9847730, 66354	Idler sheave assembly 5-1/2" O.D. with bracket and hardware (DS-34 and 34B)
DS-34B	26743	Bracket for idler sheave
MIS-300	9871421	Cable , 1/8" galvanized, for DS-34 7 x 19 strand
DS-36	9829430	Pressure spring , 15-1/2" L x 7/8" O.D.
DS-37	9722270	Contact
DS-37A	9722026	Holder , contact insulator
DS-38	9881396, 28139	Cam
DS-39	9840795, 44079	Composite selector pinion
DS-39A	9875438	Gear , pinion, 48 tooth, 100:1
DS-40	9814437	Selector Traveling Nut and HDW
DS-41	9814477	Bearing , Linear Selector
DS-42	9811230	Selector Lead Screw , 53", works w/ DS-41
DS-43	141618	DMC Selector tape , .032" x 3" W 141618
DS-44	9810078	DMC Magnet Strip , 2-1/2" L 141077
DS-45	9741070	DMC Magnet Strip , 8" L 141078
DS-46	9853388	Magnet Strip , 12" 568AA1
DS-47	9864672	Toggle Switch , Carling
ES-001	9745312	Vane Magnetic Selector Tape , ELGO Selectors, Absolute Positioning for Dover/Thyssen



DS-44



DS-45



DS-46

Transformers



DTR-1



DTR-6



DTR-7



DTR-9



DTR-10



DTR-11



DTR-13

S.E.E.S. #	O.E.M. #	V.A.	Primary Volt.	Secondary Volt.
DTR-1	9768658, 76865	150	230/460	24/48
DTR-2	9720972, 71545	250	230/276	120/230
DTR-2A	9706562, 129826	250	230/460	115/230
DTR-2B	9829829, 129827	250	230/460	24/48
DTR-3	9767848, 76784	250	230/460	35
DTR-4	9716725, 75199	500	230/460	115/230
DTR-5	9716890, 77073	750	230/460	115/230
DTR-6	9745956, 74595	1000	230/460	115/230
DTR-7	9779309, 77930	602.5	120/133/139/266/277	34.4/183
DTR-8	9779310, 77931	1182	120/133/139/266/277	93/35
DTR-9	9786971, 108697	715	200/230/240/460/480	48/24
DTR-10	9882248, 78224	1190	200/230/240/460/480	38.5/115
DTR-11	9882250, 78225	685	200/230/240/460/480	38.5
DTR-12	9871305, 77130	100	230/460	115
DTR-13	9737480	200	240/480	120/240
DTR-14	9781916, 102834	690	230/550/575/600	38.5
DTR-16	9786960	815	208/480	115
DTR-17	9754378		Transformer, PWR 1PH .5KVA -MX	120/240

Valve Components



DV-1



DV-2



DV-2A



DV-3



DV-4



DV-5



DV-6



DV-200



DV-202



DV-203



S.E.E.S. #	O.E.M. #	Description
DV-1	9788566, 28856	Solenoid seat , N.C. for up and down pilot sections, brass, 5/8" O.D. x 5/8" L with O-ring, for 9715060 plunger and needle assembly
DV-2	9788554	Solenoid seat , N.O. for 63426 and 3431 up pilot sections, steel, 5/8" O.D. x 5/8" L, for 9715060 plunger and needle assembly
DV-2A	9724722	Solenoid seat
DV-3	9731143, P150-24	Regulator spring , 11/16" O.D. x 5-3/4" L, 27 turns
DV-4	9807524, P149-7	Washer spring seat for 9731143 regulator spring, brass 11/16" O.D. x 5/8" L with steel pivot ball
DV-5	9730904, P14915	Regulator control piston for 63427 and 63432 down pilot sections, Delrin piston, 1/2" O.D. x 1-5/8" L
DV-6	9754076, 76407, 63432	Orifice control piston for 63427 and down pilot sections Delrin piston, 1/2" O.D. x 1-5/16" L
DV-201	9712112	O-Ring , for Valve P Series, #0 1.18" x 1.0625"
DV-202	9779700	Nipple NPT , Pipe, 1/8" x 1" Lo Valve and EP Power Units
DDO-51	9815855	Solenoid, Brake, Retrofit Kit , G4 & G5 w/ Armatures, sleeve & nameplate for 150 VDC 205AV1 Solenoid
DDO-52	9815818	Solenoid, Brake, Retrofit Kit , GD1, Single Solenoid, with armature, sleeve, plates, dustcover & nameplates for 140 VDC 799AE1 solenoid
DDO-53	9815806	Solenoid, Brake, Retrofit Kit , Geared Single Solenoid, w/ armature, sleeve, plates, dustcover & nameplates for 140 VDC 126689 solenoid
DV-200	9754672	O-Ring , for Valve P Series, #0 1.18" x 1.0625"
DV-200A		Coil , Solenoid Kit, 120 VAC with Plate & Nut
DV-203		Telescopic Jack Check Valve

Valve Components

Springs for Pistons on Lowering and Constant Speed Lowering Sections

S.E.E.S. #	O.E.M. #	Description
DV-7	9730254, P12533	Spring , 2-1/8" O.D. x 4-1/4" L, 5-3/4 turns
DV-8	9730760	Spring , 1-11/16" O.D. x 3-3/4" L, 6 turns
DV-9	9730564, P12579	Strainer assembly for up and down pilot sections, 7/8" hex brass body with strainer screen and O-ring
DV-10	9805590, P125139	Assembly needle valve manual for down pilot sections
DV-10A	9715060, P56431	Plunger and needle valve for Pilot Solenoids
DV-11A	9730590, P12592	Control piston spring , 7/16" O.D. x 1-1/16" L
DV-11B	9754064, 75406	Orifice spring , 1/4" O.D. x 1-3/4" L
DV-12	9861610, 66161	Assembly needle valve for up and down pilot sections
DV-13	9730576, P12590	Control piston for up and down section, steel piston 1/2" O.D. x 1-3/4"
DV-46	9724709	Gasket , Tube Valve Pilot Solenoid
DV-47	9897227	Valve , Integral Valve
DV-48	9842007	Valve , I-3
DV-100	9722282	Washer , Insulated, 2-1/4" Diameter
DV-100A	100010	Post Insulating Bushing used w/ SEES DV-100
DV-102	9729124, 9781456	Adjuster Leveling Kit , I-1 & I-2 Valve, with "O" rings
DV-103	9729525	Adjuster Leveling Kit , I-3, with "O" rings
DPAC-31D	9824467	Strainer Assembly , Valve 1-2, .3125" Diameter, Stainless Steel

Valve Coils

S.E.E.S. #	O.E.M. #	Description
DV-15	9715563	Solenoid coil , 115 VAC, I.D. 3/4", O.D. 2-3/4", 2-1/8" L, 1386 Coil
DV-15A	9803452	Solenoid coil Kit , 120 VAC with Flux Plate & Nut
DV-16	9753965, 75396 9715575, 9755895	Solenoid coil , 115-230 VAC, I.D. 3/4", O.D. 2-3/4", 2-1/8" L, Coil 1224
DCO-5	9722300	Coil , works with I-2 & I-3 Valves, 120 VAC, I.D. 1/2", O.D. 1-1/4", 1-1/4" L
DCO-6	9768981	Coil , 24 VDC, I.D. 7/8", O.D. 1-7/8", 1-7/8" L

Valve Springs

S.E.E.S. #	O.E.M. #	Description
DV-27	9730163	Spring , 3/4" O.D. x 2-3/4"
DV-28	9730140	Spring , 3/4" O.D. x 2-3/8"
DV-29	9730151	Spring , 3/4" O.D. x 2-3/8"

Silencer Components

S.E.E.S. #	O.E.M. #	Description
KHM-001	9817843, USP12000/USP12000019	Muffler , 2" x 2" x 18.5" Pancake Style Muffler, Grooved
KHM-002	9726731	Muffler , 2" Submersible
DV-34	9848836, 44883	Core , with springs for muffler for 2" and 3" Silencer



Valve Components



DV-24



DV-37

DV-40

DV-44

Wheels and Rollers

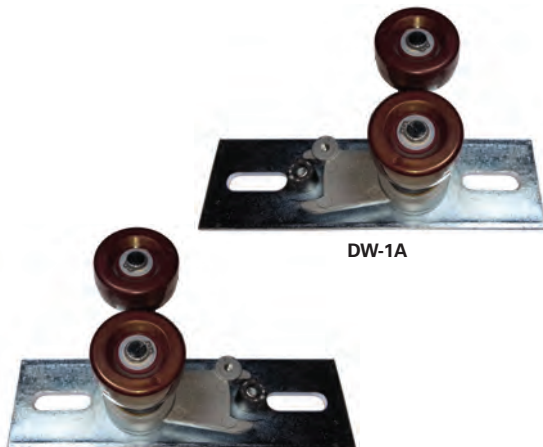

DW-1A

DW-1A-R



DW-1

S.E.E.S. #	O.E.M. #	Description
DV-24	9754179	Repair Kit , Gasket/O-ring repair kit, for P125 and P126 Valve
DV-25	9754179	Repair Kit , O-ring repair kit, for 60,000 series oildraulic
DV-26	9708327	Repair Kit , Gasket/O-ring repair kit, for 60,000 series/lowering-down
DV-30	9732860	Repair Kit , Gasket/O-ring repair kit for I-2 Valve
DV-30A	9720911	Repair Kit , Gasket/O-ring repair kit for I-3 Valve
DV-35	9723067	Seal , neoprene valve seal P-144-5

* See more seals starting on pg 390.

Valve Gaskets, O-Rings, Repair Kits

S.E.E.S. #	O.E.M. #	Description
DV-17	9707750	Gasket
DV-18	9708108	Gasket
DV-19	9708145	Gasket
DV-20	9724941	Gasket
DV-22	9708169	Gasket
DV-23	9731260	Gasket
DV-21	9709733	O-Ring
DV-31	9709861	O-Ring
DV-32	9709903	O-Ring
DV-33	9754647	O-Ring
DV-36	9742943	O-Ring
DV-37	9754660	O-Ring
DV-38	9709812	O-Ring
DV-39	9709836	O-Ring
DV-40	975470	O-Ring
DV-41	9754635, 75463	O-Ring
DV-44	9754659	O-Ring , for I-2 Valve, 13/16" x 15/16"
DV-45	9754817	O-Ring , 3.375" O.D. x 3.125" I.D.

S.E.E.S. #	O.E.M. #	Description
DW-1A	9875256, 47525	Pick-up roller assembly , 1-5/8" dia., polyurethane rollers with a STEEL mounting base. Assembled L.H. (interchangeable L.H. or R.H.)
DW-1A-R	9875268, 47525	Pick-up roller assembly , as above. Assy R.H. (interchangeable R.H. or L.H.)
DW-1	9838351, 63835	Replacement roller kit for door pick-up roller assembly 1-5/8" dia., polyurethane with bronze bushing, nylon washers and retaining ring

Wheels and Rollers

S.E.E.S. #	O.E.M. #	Description
DW-1B	9897641, 29764	Steel base for pick-up roller assembly
DW-1C	9736141, 70115	Retaining ring for DW-1
DW-1D	9801157	Shaft for DW-1 pick-up rollers
DW-1E	9838181, 47529	Roller crank
DW-1F	9759268, 75926	Retaining ring for 1" shaft
DW-1H	9870052	Bumper, for Door Pick Up Assy DW-1A, DW-1A-R
DDO-42	860AE14	Car Door Hanger Rail 98" Dover, "J" (no holes)



DW-1F

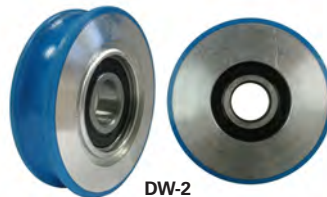

DW-2

S.E.E.S. #	O.E.M. #	Description
DW-2A	9838340	Hanger assembly, low pocket, consists of mounting bracket DW-2B, hanger roller DW-2, and eccentric upthrust shaft DW-9, with roller tire assembly DW-10
DW-2	9838302, 63830	Hatch door hanger roller, .6693" I.D. aluminum with polyurethane tires, 2-7/8" dia.
DW-2B	9752249	Frame, low pocket hanger
DW-2C		Hanger Assy Rebuild Kit, Low Pocket Hanger
DW-3A	9838533	Hanger assembly, high pocket, consists of mounting bracket DW-3B, hanger roller DW-3, and eccentric upthrust shaft DW-9, with roller tire assembly DW-10
DW-9	9752160	Eccentric upthrust shaft, 3/4" x 1-3/8" L, used with DW-10, 1/8" shoulder
DW-9A	9861191	Eccentric upthrust shaft, 1-3/8" O.D.
DW-10	9875426, 67542	Roller tire assembly, for DW-9
DW-10A		Bearing, 5/8" I.D. x 3/4" L (heavy duty replacement for DW-10)
DW-3	9864295	Hanger roller, .6693" I.D., steel with polyurethane tire, 3-5/16" diameter
DW-3B	9752158	Frame, high pocket hanger



DW-1B



DW-1D



DW-1E



DW-2A



DW-2B



DW-10



DW-3A



DW-10A



DW-9



DW-9A



DW-3



DW-3B



DW-5



DW-5A



DW-6A

Sheave and Bracket Assembly

S.E.E.S. #	O.E.M. #	Description
DW-5	9811102, E40034	Sheave and bracket assembly, for vertical gate
DW-5A		Sheave, 3.275" O.D. x .750" I.D. for DW-5 sheave assy.
DW-6	9831873, 63187	Roller guide wheel, 4" O.D. x 3/4" W, single bearing, .6693" I.D., 1/2" tire face
DW-6A	29253	Eccentric shaft for roller guide wheel DW-6
DW-6H	D421, 9831873	Roller Guide Wheel, 4" O.D. x 3/4" W x .6693" I.D., HD 90 Duro
DW-7	9872309	Counterweight roller guide, 3" O.D., 13/16" W, bearing .7874"
DW-7S		Counterweight roller guide, 3" O.D., 13/16" W, bearing .7874", soft poly



DW-6

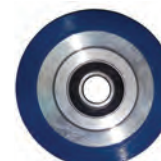

DW-6H



DW-7



DW-7S

Wheels and Rollers



S.E.E.S. #	O.E.M. #	Description
DW-8	9832774, 63277	Roller guide wheel , 4" O.D. x 1-1/4" W, tire face 1/2" W, two bearings, .6693" I.D.
DW-8A	9786600, 28660	Shaft, Roller guide shaft , .45199
DW-8B	29161	Spacer
DW-8H	9832774, D420	R.G. Wheel , 4" O.D. x 1-1/4" W x .6693" ID, HD 90 Duro
DW-9*	9752160	Eccentric upthrust shaft , 3/4" x 1-3/8" L, used with DW-10, 1/8" shoulder
DW-9A*	9861191	Eccentric upthrust shaft , 1-3/8" O.D.
DW-10*	9875426, 67542	Roller tire assembly , for DW-9
DW-10A		Bearing , 5/8" I.D. x 5/8" L (heavy duty replacement for DW-10)
* Used on DW-2A & DW-3A Hanger Assemblies – See page 601.		
DW-11	9819745	Roller Guide Wheel , 2-5/8" O.D. counter weight, Omega
DW-12	9801236, 40121	Spacer , arm bearing, used with DDO-21, 21A, 25, 25A
DW-12A	9801170, 40117	Spacer for door hanger, used with DDO-21, 21A, 25, 25A
DW-12B	9700742	Screw socket , 3/8-16 x 1-1/4"
DW-14	9831824, 63182	Roller guide wheel , 8" O.D., .7874" I.D., two bearings
DW-14A	27728, 9747620	Shaft for DW-14 Roller
DW-14B	9828746	Bolt , adapter kit to change old style Warner and Warsaw 8" rollers to fit DW-14
DW-14C	9747424	Shoulder Bolt , for Roller Guide, 5/8-11 thread, 13/16" OL
DW-14H	9831824, D423	Roller guide wheel , 8" O.D. x .7874" I.D., HD 90 Duro
DW-15	9834734, 103473	Roller guide wheel , 3" O.D., .668" Bearing I.D., used on roller assembly #103477
DW-15A	155804	Roller Guide Wheel , 3-1/4" O.D. 1" W, 1/2" Face .669" I.D.
DW-16	9766169	Roller , tach generator, 3" O.D., 5/16" I.D., steel hub, 60 durometer poly tire, no bearing
DW-16A	9715447	Roller , tach generator, 3" O.D., 1/2" I.D.
DW-16B		Tach Roller , 3" O.D. x 5/8" I.D.
DW-17	9861245	Roller , hanger, 3-1/4" O.D. aluminum wheel with urethane tire for assembly #66137
DW-18		Roller guide wheel , 5" O.D., .985" I.D., replaces Watson roller
DW-19	9713311	Eccentric , for door
DW-20	9738733	Upthrust Roller
DW-21	9780180	Roller
DW-200	9728549, 277AM1	Door Retainer , for Door Track, Right Hand
DW-201	9728548, 277AM2	Door Retainer , for Door Track, Left Hand
DRG-001	9747825	Arm , Roller L.H. 8", for roller guide 67960
DRG-002	9747722	Arm , Roller R.H. 8", for roller guide 67960
DRG-003	9747928	Bearing , Bronze 7/8" I.D. x 1-1/8" O.D. x 1-1/2" L, for roller guide 67960